

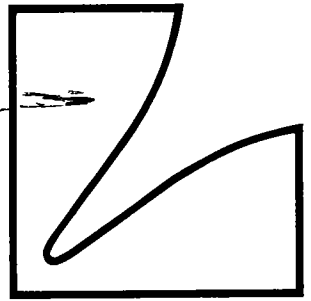

For more Hi-Fi manuals and set-up information
please visit www.hifiengine.com

SERVICE MANUAL



Stereo Integrated Amplifier

LV-105u

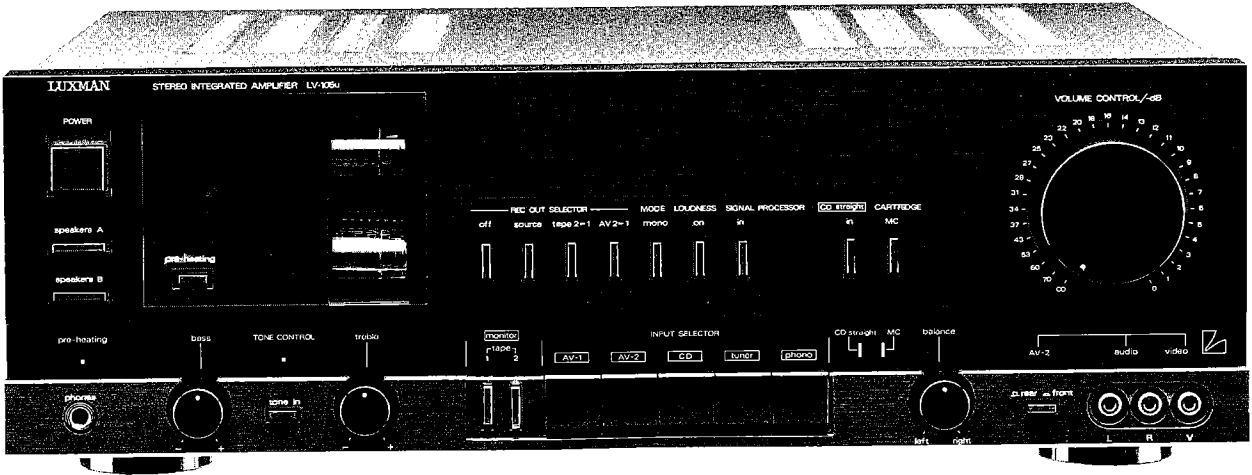

Contents

Specifications	3
Parts Locations and Disassembly Instructions	4 to 9
Adjustment Procedures	10
Adjustment Locations	11
Block Diagram	12
Schematic Diagram	13 to 15
Parts Layout on P. C. Boards and Wiring Diagram (1/3)	16 to 18
Parts Layout on P. C. Boards and Wiring Diagram (2/3)	19 to 21
Parts Layout on P. C. Boards and Wiring Diagram (3/3)	22 to 24
Electrical Parts List	24 to 31
Cabinet Assembly Parts List	32
Exploded View (Cabinet)	33 to 34
Packing Assembly Parts List	35
Packing Method View	35
Parts List by the Destination	36 to 38
Semi-Conductor Lead Identifications	39 to 41

Specifications

Power Output	70W (0.25%THD at 20Hz~20KHz)
Headphones Output	(80W/8 Ω -1KHz) 650mV \pm 10%
Input Sensitivity (1KHz)	CD : 150mV \pm 15%
	Tuner : 150mV \pm 15%
	Tape-1, 2 : 150mV \pm 15%
	AV-1, 2 : 150mV \pm 15%
	Adaptor : 150mV \pm 15%
	Phono (MM) : 2mV \pm 15%
	Phono (MC) : 150 μ V \pm 15%
Input Impedance (1KHz)	CD : 47K ohm \pm 15%
	Tuner : 47K ohm \pm 15%
	Tape-1, 2 : 47K ohm \pm 15%
	AV-1, 2 : 47K ohm \pm 15%
	Adaptor : 47K ohm \pm 15%
	Phono (MM) : 47K ohm \pm 15%
	Phono (MC) : 100 ohm \pm 15%
Frequency Response	CD : 10-100KHz+0.6-2dB
	Tuner : 10-100KHz+0.6-2dB
	Tape-1, 2 : 10-100KHz+0.6-2dB
	Phono (MM) : 100Hz \pm 0.5dB
	Phono (MC) : 10KHz \pm 0.5dB
Signal to Noise Ratio	CD : 81.5dB
(Input Shorted)	Tuner : 81.5dB
	AV-1, 2 : 81.5dB
	Adaptor : 81.5dB
	Phono (MM) : 69.4dB
	Phono (MC) : 47.5dB
Cross Talk	CD : 45dB
	Tuner : 45dB
	Tape : 45dB
	Adaptor : 45dB
	Phono : 40dB
Power Supply	100V, 50/60Hz (JM Model Only)
	120V, 60Hz (UL/UN Model Only)
	220V, 50Hz (AM Model Only)
Power Consumption	185W (JM Model Only)
	2.3A (UL/UN Model Only)
	3.5A (AM Model Only)
Semiconductors	7 IC's, 43 Transistors, 14 Zener Diodes,
	10 FETs 33 Diodes, 2 Vacuum Tubes
Dimension	438 (W) \times 148 (H) \times 353 (D) mm
Weight	11.5Kg

NOTE: Due to continuing product improvement, specifications and design are subject to change without notice.

Parts Locations and Disassembly Instructions

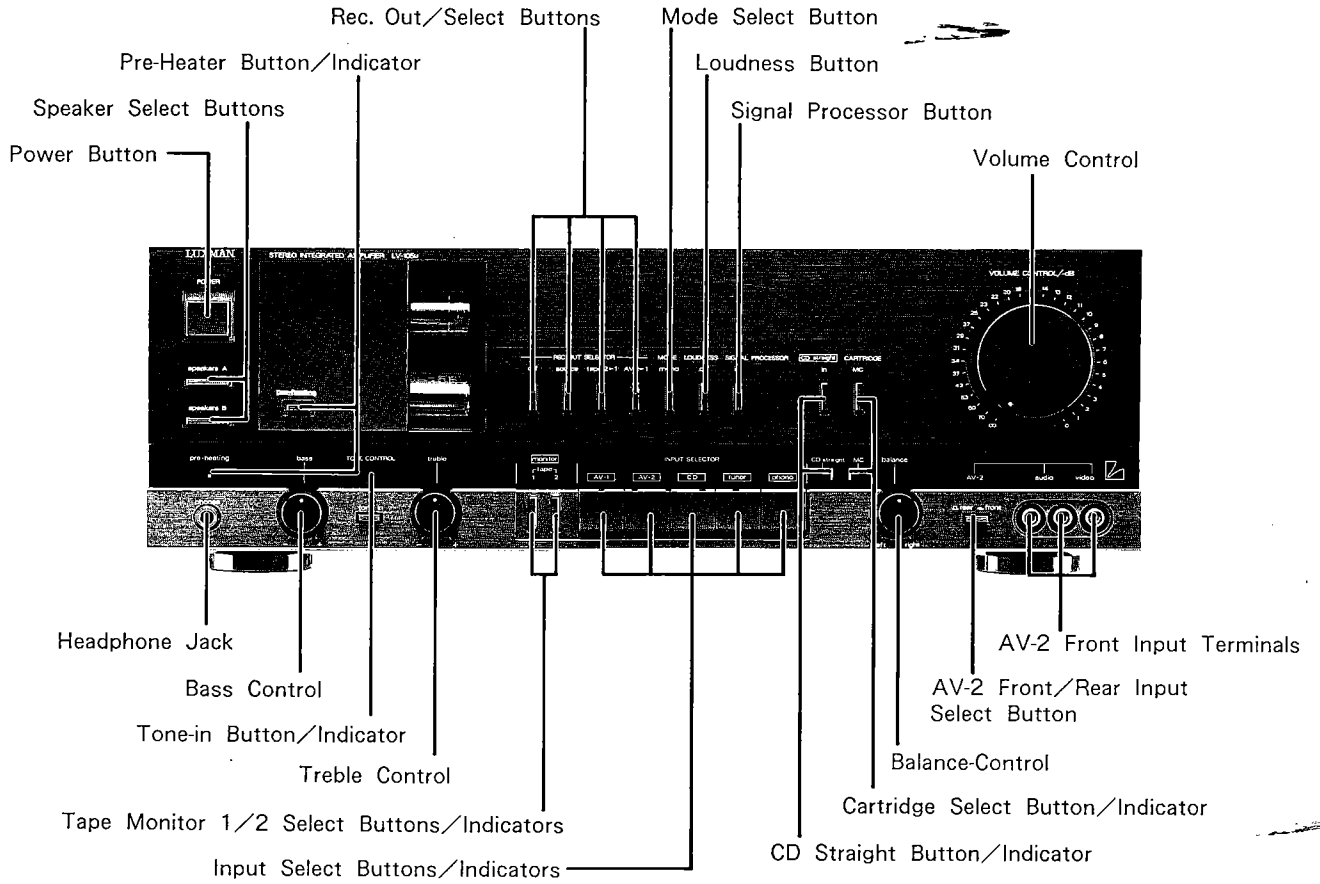

Figure 1

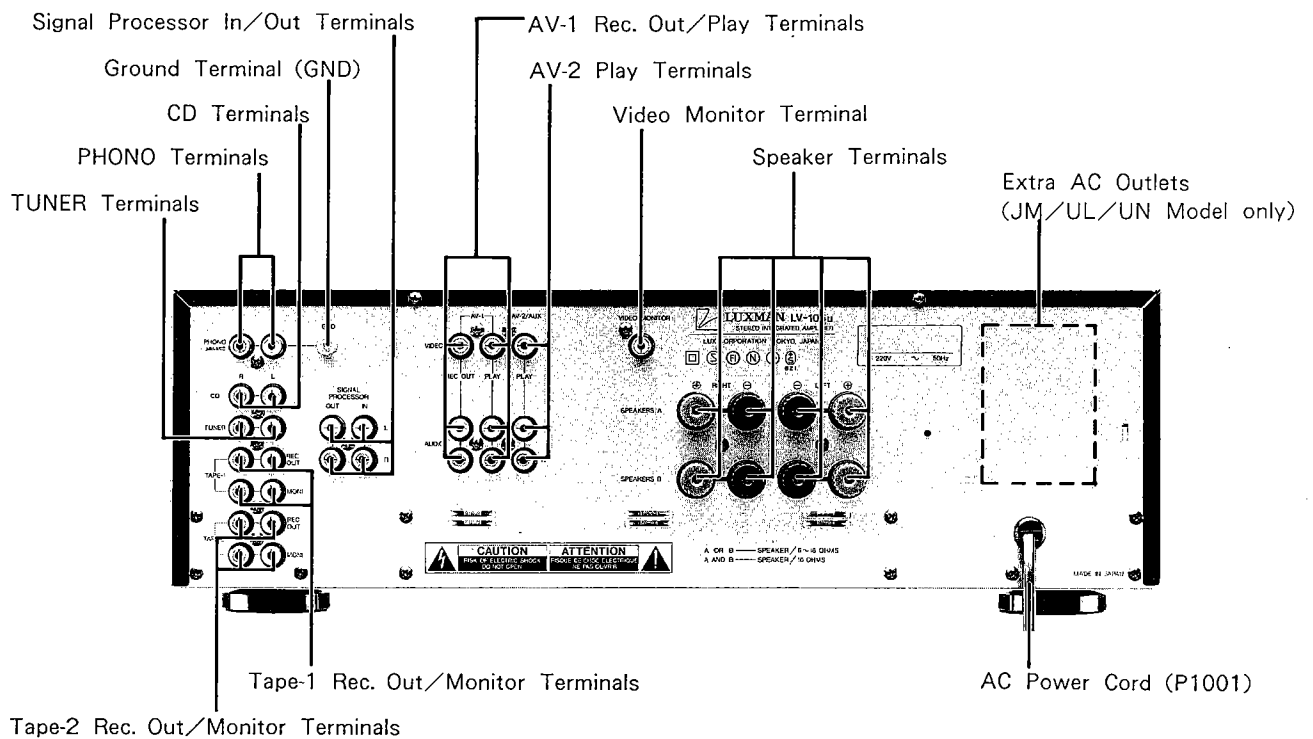

Figure 2

1. Removal of Top Cover

- (1) Remove six screws marked "○" as shown in Figures 3 and 4.
- (2) Pull out the top cover in the direction of the arrow as shown in Figure 3.

1. 上蓋の外し方

- (1) 6本のネジ(○印)を外します。(3、4図参照)
- (2) 上蓋を矢印の方向に引き上げれば、上蓋は外れます。(3図参照)

2. Removal Front Panel

- (1) Remove the volume control knob as shown in Figure 3.
- (2) Remove three screws marked "⊗" as shown in Figure 5.
- (3) The Front Panel can be removed by pulling it forward.
But when the panel is engaged tightly, pull the panel end little by little, and the panel will be removed easily.

2. フロント・パネルの外し方

- (1) ボリューム調整ツマミを外します。(3図参照)
- (2) 3本のネジ(○印)を外します。(5図参照)
- (3) 手前に引けばフロント・パネルは外せます。パネルがきつくはまっている場合は、少しずつ引きます。パネルは簡単に外せます。

3. Removal of Front Escutcheon

- (1) After removal of The Front Panel, remove three control knobs (bass, treble, balance), remove two hooks (A), and remove six screws marked "※" as shown in Figures 3, 4 and 6.
- (2) Disconnect all wires from the Front Escutcheon.
- (3) The Front Escutcheon with Function LED, Tone and Headphone P. C. Boards can be removed completely.

3. フロント・エスカッションの外し方

- (1) フロント・パネルを外してから、3個の調整ツマミ(バス、トレブル、バランス)、2箇所のフック(A)及び6本のネジ(※印)を外します。(3、4、6図参照)
- (2) フロント・エスカッションから出ている全てのリード線を外します。
- (3) 以上でフロント・エスカッションと一緒にファンクションLED基板、トーン及びヘッドホン基板は外れます。

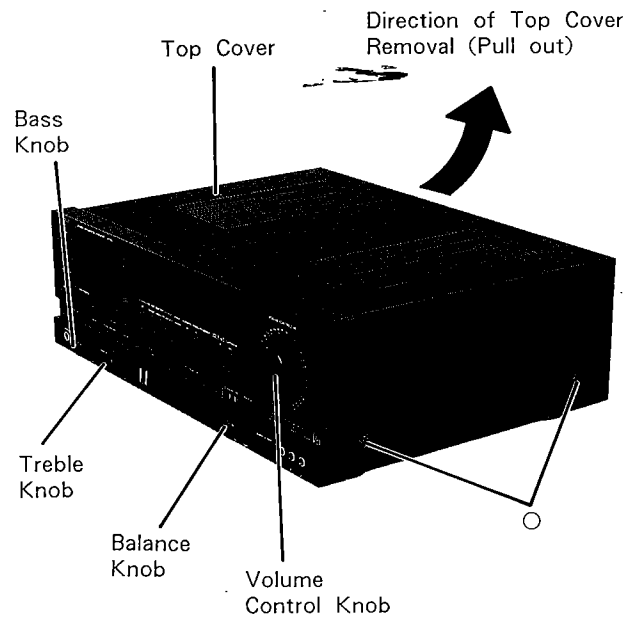

Figure 3

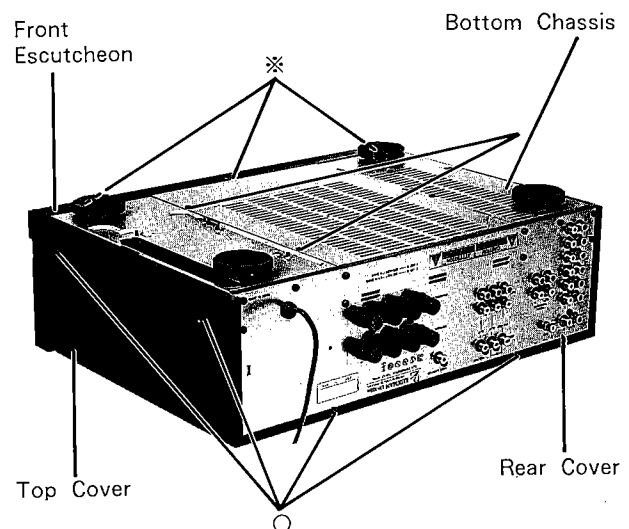

Figure 4

4. Removal of Function LED P. C. Board

(1) After removal of Front Escutcheon, remove four hooks (B) as shown in Figure 7.

4. ファンクションLED基板の外し方

(1) フロント・エスカッションを外してから、4箇所のフック (B) を外します。(7図参照)

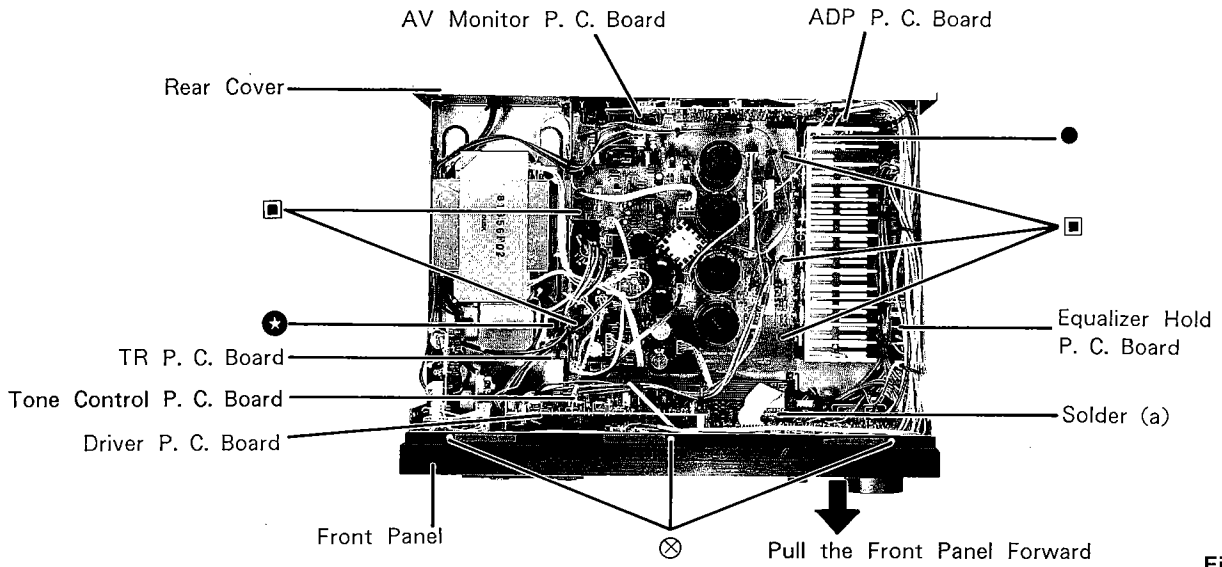

Figure 5

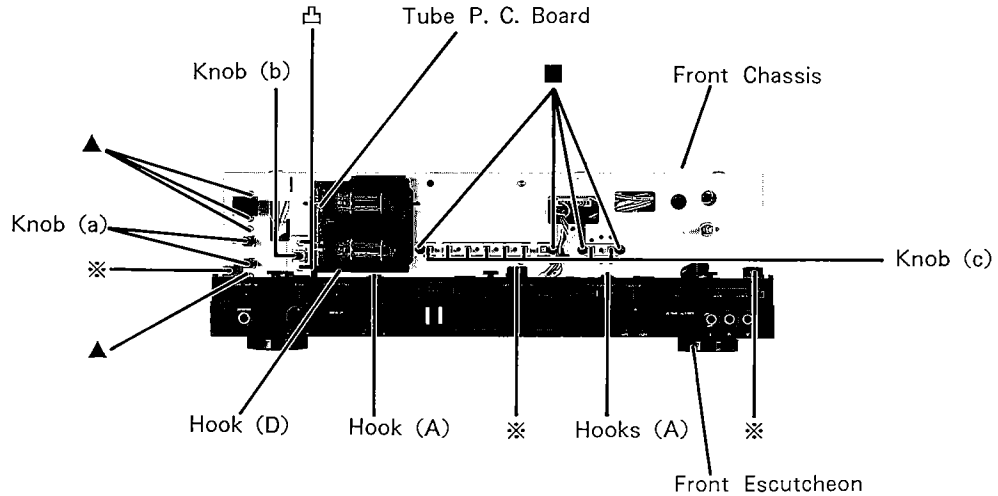

Figure 6

5. Removal of Tone Control LED P. C. Board

(1) After removal of Front Escutcheon, remove two hooks (C) as shown in Figure 7.

5. トーン・コントロールLED基板の外し方

(1) フロント・エスカッションを外してから、2箇所のフック (C) を外します。(7図参照)

6. Removal of Headphone P. C. Board

(1) After removal of Front Escutcheon, remove two screws marked "◎" as shown in Figure 7.

6. ヘッドホン基板の外し方

(1) フロント・エスカッションを外してから、2本のネジ (◎印) を外します。(7図参照)

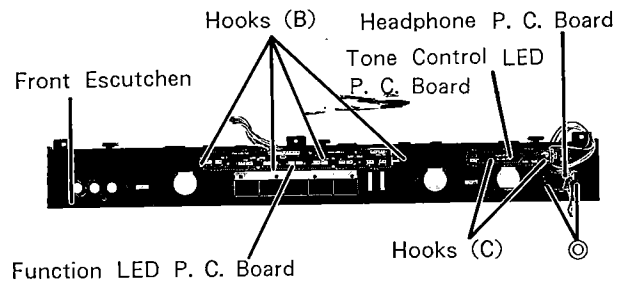

Figure 7

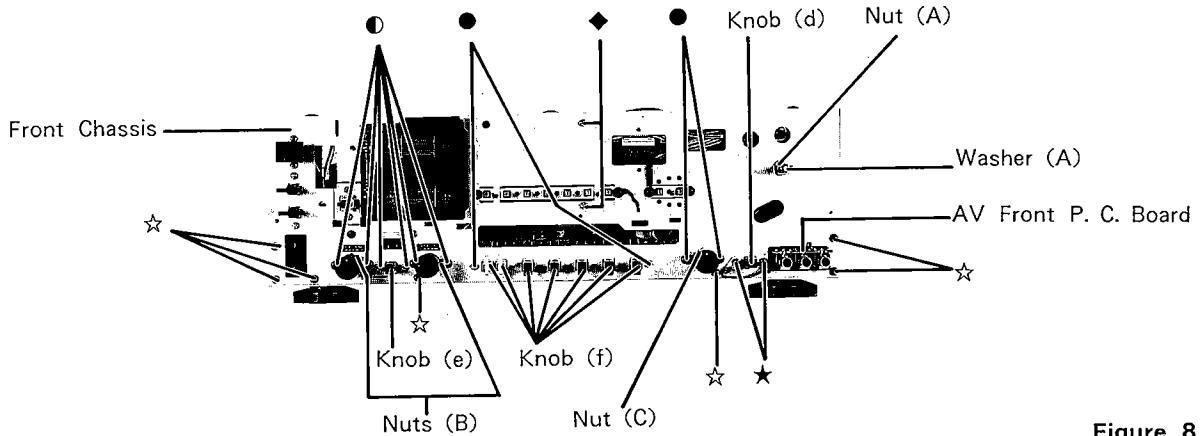

Figure 8

7. Removal of Front Chassis

(1) After removal of Front Escutcheon, remove seven screws marked "☆" as shown in Figure 8.
 (2) Remove Front Chassis upward and then proceed to items 7-1~7-10.

7. フロント・シャーシの外し方

(1) フロント・シャーシを外してから、7本のネジ (☆印) を外します。(8図参照)
 (2) フロント・シャーシを上方に外します。続いて7-1から7-10に進みます。

7-1 Removal of Driver P. C. Board

(1) Remove two screws marked "◆" as shown in Figure 8.
 (2) Disconnect all wires from the Driver P. C. Board.

7-1 ドライバー基板の外し方

(1) 2本のネジ (◆印) を外します。(8図参照)
 (2) ドライバー基板から出ている全てのリード線を外します。

7-2 Removal of Transistor P. C. Board

(1) Remove a screw marked "★" as shown in Figure 5.
 (2) Disconnect all wires from the Transistor P. C. Board.

7-2 トランジスター基板の外し方

(1) 1本のネジ (★印) を外します。(5図参照)
 (2) トランジスター基板から出ている全てのリード線を外します。

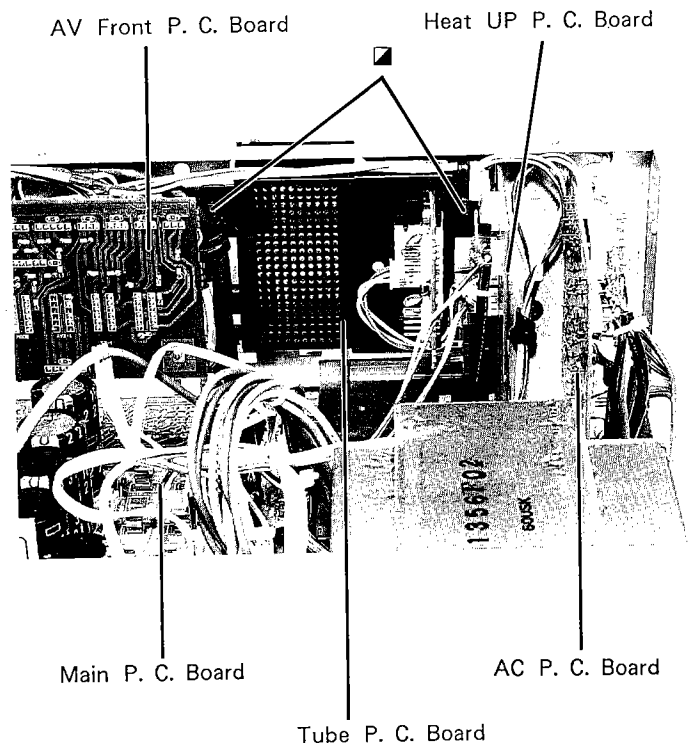

Figure 9

7-3 Removal of AC P. C. Board

- (1) Remove two knobs (a) and remove four screws marked "▲" as shown in Figure 6.
- (2) Disconnect all wires from the AC P. C. Board.

7-3 AC基板の外し方

- (1) 2個のつまみ (a) と4本のネジ (▲印) を外します。(6図参照)
- (2) AC基板から出ている全てのリード線を外せば、基板は外せます。

7-4 Removal of Heat-UP Switch P. C. Board

- (1) Remove one knob (b) and remove two screws marked "凸" as shown in Figure 6.
- (2) Disconnect all wires from the Heat-up Switch P. C. Board.

7-4 ヒートアップ・スイッチ基板の外し方

- (1) 1個のつまみ (b) と2本のネジ (凸印) を外します。(6図参照)
- (2) ヒートアップ・スイッチ基板から出ている全てのリード線を外せば、基板は外せます。

7-5 Removal of Tube P. C. Board

- (1) Remove two screws marked "■" as shown in Figure 9.
- (2) Remove one hook (D) as shown in Figure 6.
- (3) Disconnect all wires from the Tube P. C. Board.

7-5 チューブ基板の外し方

- (1) 2本のネジ (■印) を外します。(9図参照)
- (2) 1箇所フック (D) を外します。(6図参照)
- (3) チューブ基板から出ている全てのリード線を外します。

7-6 Removal of REC P. C. Board

- (1) Remove four screws marked "■" and remove nine knobs (C) as shown in Figure 6.
- (2) Disconnect all wires from the REC P. C. Board.

7-6 REC基板の外し方

- (1) 4本のネジ (■印) と9個のつまみ (C) を外します。(6図参照)
- (2) REC基板から出ている全てのリード線を外します。

7-7 Removal of Volume Control P. C. Board.

- (1) Remove one nut (A) and one washer (A) as shown in Figure 8.
- (2) Disconnect all wires from the Volume Control P. C. Board.

7-7 ボリューム・コントロール基板の外し方

- (1) 1個のナット (A) とワッシャー (A) を外します。(8図参照)
- (2) ボリューム・コントロール基板から出ている全てのリード線を外します。

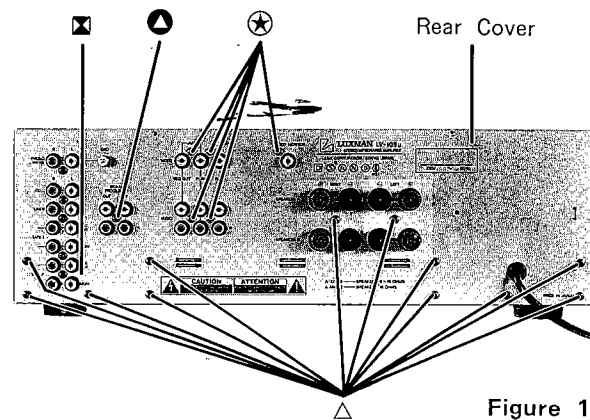

Figure 10

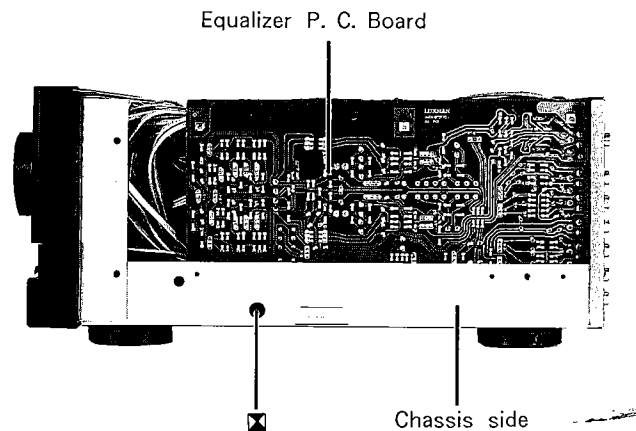

Figure 11

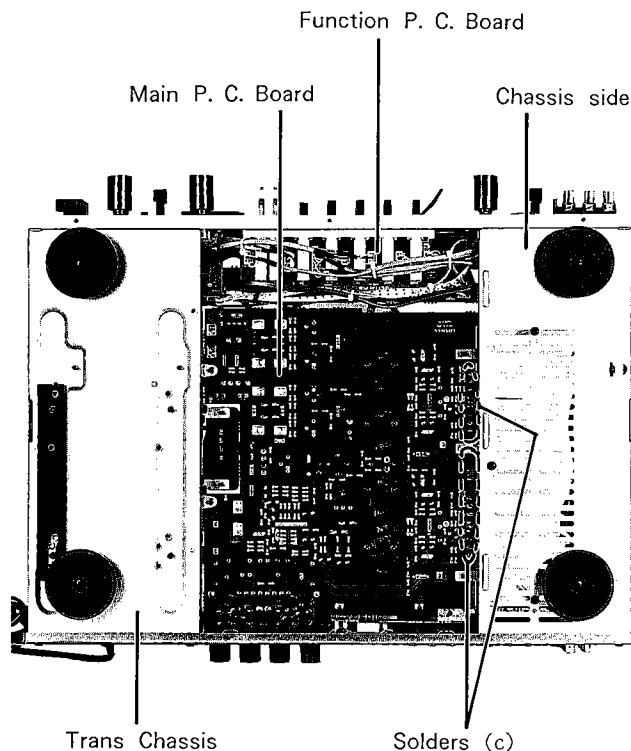

Figure 12

7-8 Removal of Tone Control P. C. Board

- (1) Remove one knob (e) and six screws marked "●" as shown in Figure 8.
- (2) Remove two nuts (B) as shown in Figure 8.
- (3) Disconnect all wires from the Tone Control P. C. Board.

7-8 トーン・コントロール基板の外し方

- (1) 1個のつまみ (e) と6本のネジ (●印) を外します。(8図参照)
- (2) 2個のナット (B) を外します。(8図参照)
- (3) トーン・コントロール基板から出ている全てのリード線を外せば基板は外せます。

7-9 Removal of Function P. C. Board and Balance P. C. Board

- (1) Remove seven knobs (f) and remove five screws marked "●" as shown in Figure 5 and 8.
- (2) Remove one nut (c) as shown in Figure 8.
- (3) Remove a solder (a) as shown in Figure 5.
- (4) Disconnect all wires from the Function P. C. Board and Balance P. C. Board.

7-9 ファンクション基板及びバランス基板の外し方

- (1) 7個のつまみ (f) と5本のネジ (●印) を外します。(8図参照)
- (2) 1個のナット (c) を外します。(8図参照)
- (3) 1箇所半田 (a) を外します。(5図参照)
- (4) ファンクション基板とバランス基板から出ている全てのリード線を外します。

7-10 Removal of AV Front P. C. Board.

- (1) Remove one knob (d) and remove two screws marked "★" as shown in Figure 8.
- (2) Disconnect all wires from the AV Front P. C. Board.

7-10 AVフロント基板の外し方

- (1) 1個のつまみ (d) と2本のネジ (★印) を外します。(8図参照)
- (2) AVフロント基板から出ている全てのリード線を外せば基板は外れます。

8. Removal of Equalizer P. C. Board.

- (1) Remove six screws marked "■" as shown in Figures 10 and 11.
- (2) Remove the Equalizer Hold Panel as shown in Figure 5.
- (3) Disconnect all wires from the Equalizer P. C. Board.

8. イコライザー基板の外し方

- (1) 6本のネジ (■印) を外します。(10、11図参照)
- (2) イコライザー・ホールドパネルを外します。(5図参照)
- (3) イコライザー基板から出ている全てのリード線を外します。

9. Removal of Rear Cover

- (1) Remove twelve screws marked "△" as shown in Figure 10.
- (2) Disconnect all wires from the AC Outlet, AV Monitor and ADP P. C. Boards.
- (3) The rear cover with AV Monitor and ADP P. C. Boards can be removed completely.

9. 後面カバーの外し方

- (1) 12本のネジ (△印) を外します。(10図参照)
- (2) ACアウトレット基板、AVモニター基板及びADP基板を外します。
- (3) 後面カバーと一緒にAVモニター基板及びADP基板が外れます。

10. Removal of AV Monitor P. C. Board

- (1) Remove five screws marked "★" as shown in Figure 10.

10.AVモニター基板の外し方

- (1) 5本のネジ (★印) を外せば、基板は外せます。(10図参照)

11. Removal of ADP P. C. Board

- (1) Remove one screw marked "○" as shown in Figure 10.

11.ADP基板の外し方

- (1) 1本のネジ (○印) を外せば、基板は外れます。(10図参照)

12. Removal of Bottom Chassis

- (1) Remove two screws marked "■" as shown in Figure 4.

12.底面シャーシの外し方

- (1) 2本のネジ (■印) を外せば底面シャーシは外れます。(4図参照)

13. Removal of Main P. C. Board

- (1) Remove five screws marked "■" and two solders (c) as show in Figures 5 and 12.
- (2) Disconnect all wires from the Main P. C. Board.

13.メイン基板の外し方

- (1) 5本のネジ (■印) と2箇所半田 (c) を外します。(5、12図参照)
- (2) メイン基板から出ている全てのリード線を外せば、基板は外れます。

Adjustment Procedures

1. Connections

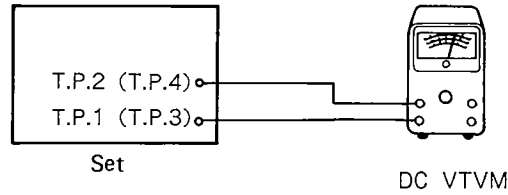

Figure 13

2. Control Settings

Power Switch ON
 Volume Control Knob Minimum
 (fully counterclockwise)
 Treble Control knob Center Position

Bass Control knob Center Position
 Balance Control knob Center Position
 Others OFF

3. Adjustment Procedures

(1) Idling Adjustment (Figure 13)

Adjust VR7301 (VR7302) until 65mV is obtained between T.P.1 (T.P.3) and T.P.2 (T.P.4).

Note: This adjustment should be made approx. 5 minutes after the power on.

調整方法

1. 接続図

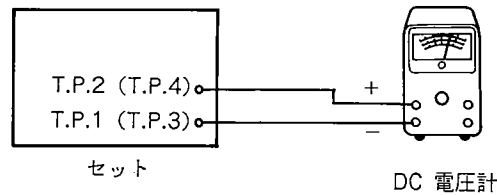

<13図>

2. スイッチ類の位置

電源スイッチ ON
 ボリューム調整つまみ 最小
 (反時計方向)
 トレブル調整つまみ 中央

バス調整つまみ 中央
 バランス調整つまみ 中央
 その他 OFF

3. 調整方法

(1) アイドリング調整 (13図参照)

テストポイント1 (3) と2 (4) の間が65mVになるまで、VR7301で調整します。

注: この調整は電源を入れてから最低5分後に行ないます。

Adjustment Locations

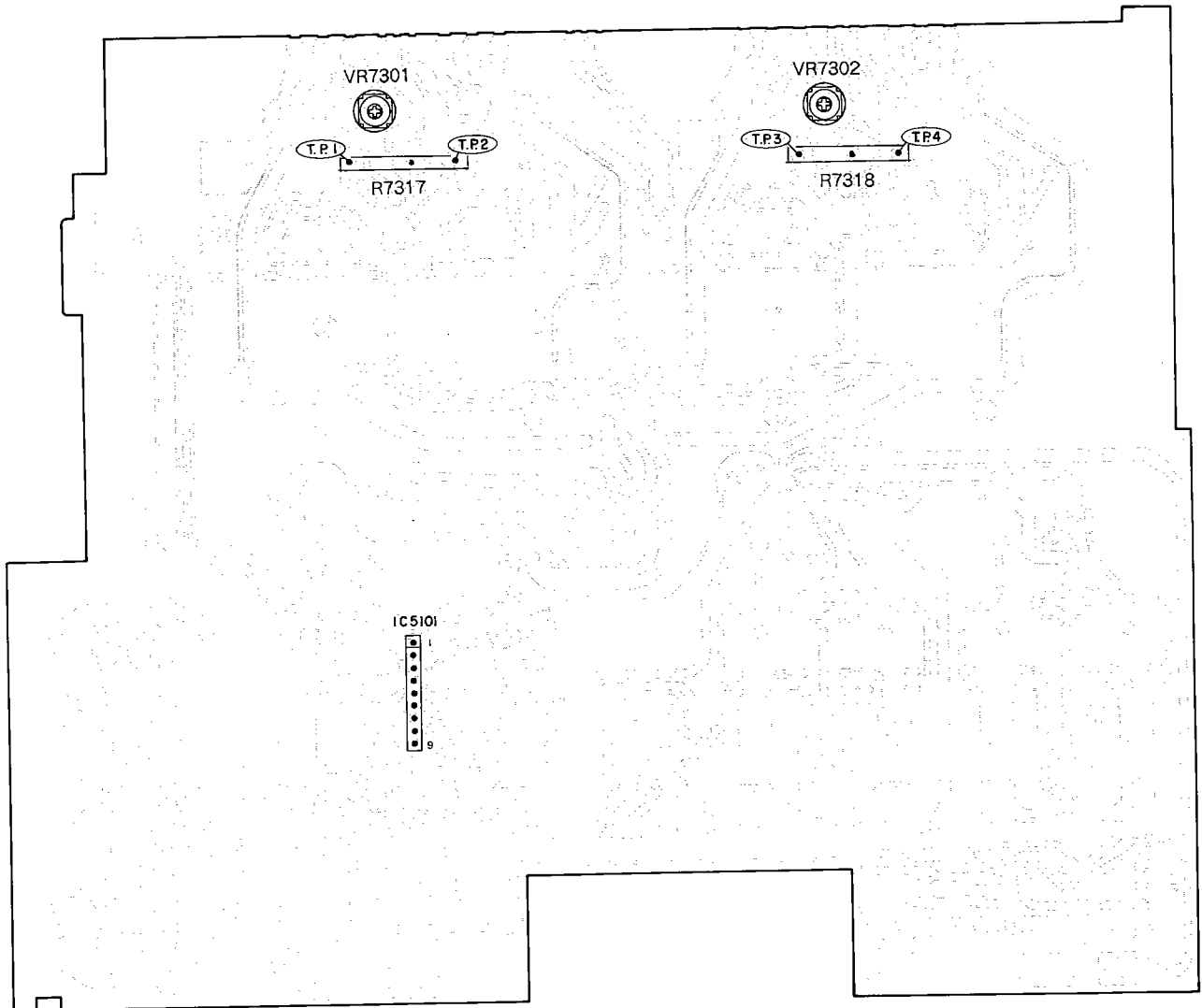

< Figure 14 >

< 14 図 >

Main P.C. Board

メイン基板

Block Diagram

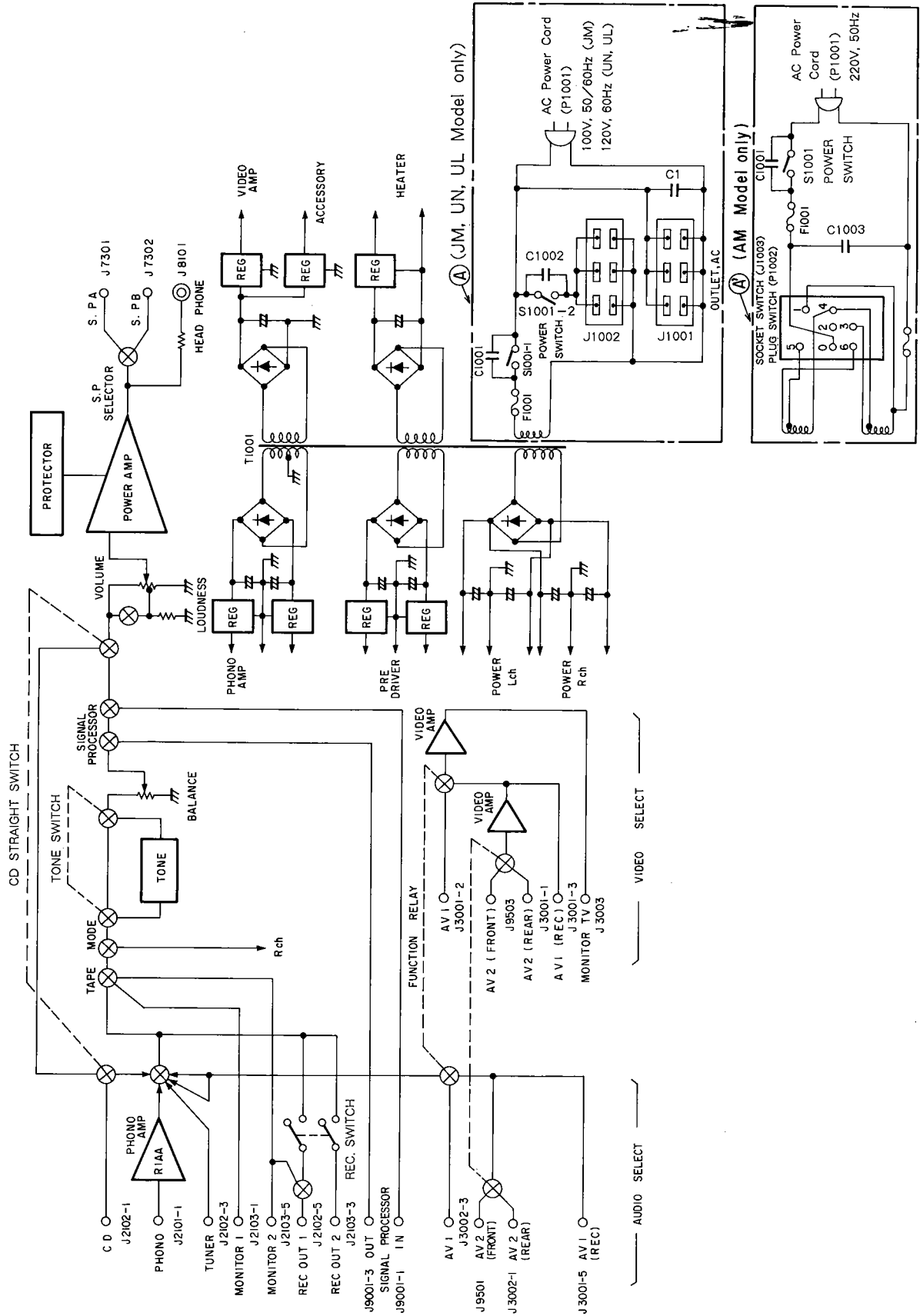

01010 ~ 01108
07101-1 ~ 07107
07108-1 ~ 07108-2
07109-1 ~ 07110
09301 ~ 09302
1C4101-1 ~ 1C4101-2
07301 ~ 07312
1C4102-1 ~ 1C4102-1
03104
1C3101
1C1119 1C1120
03101 ~ 03105
00111
01012

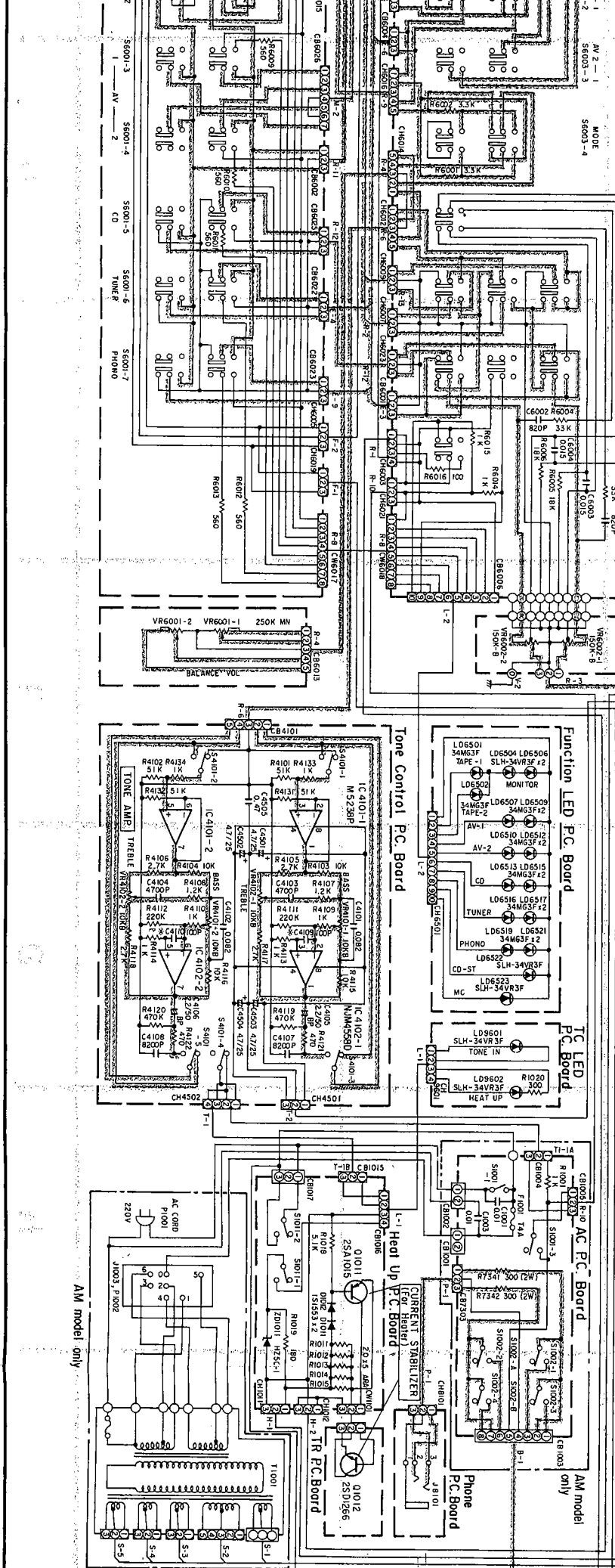
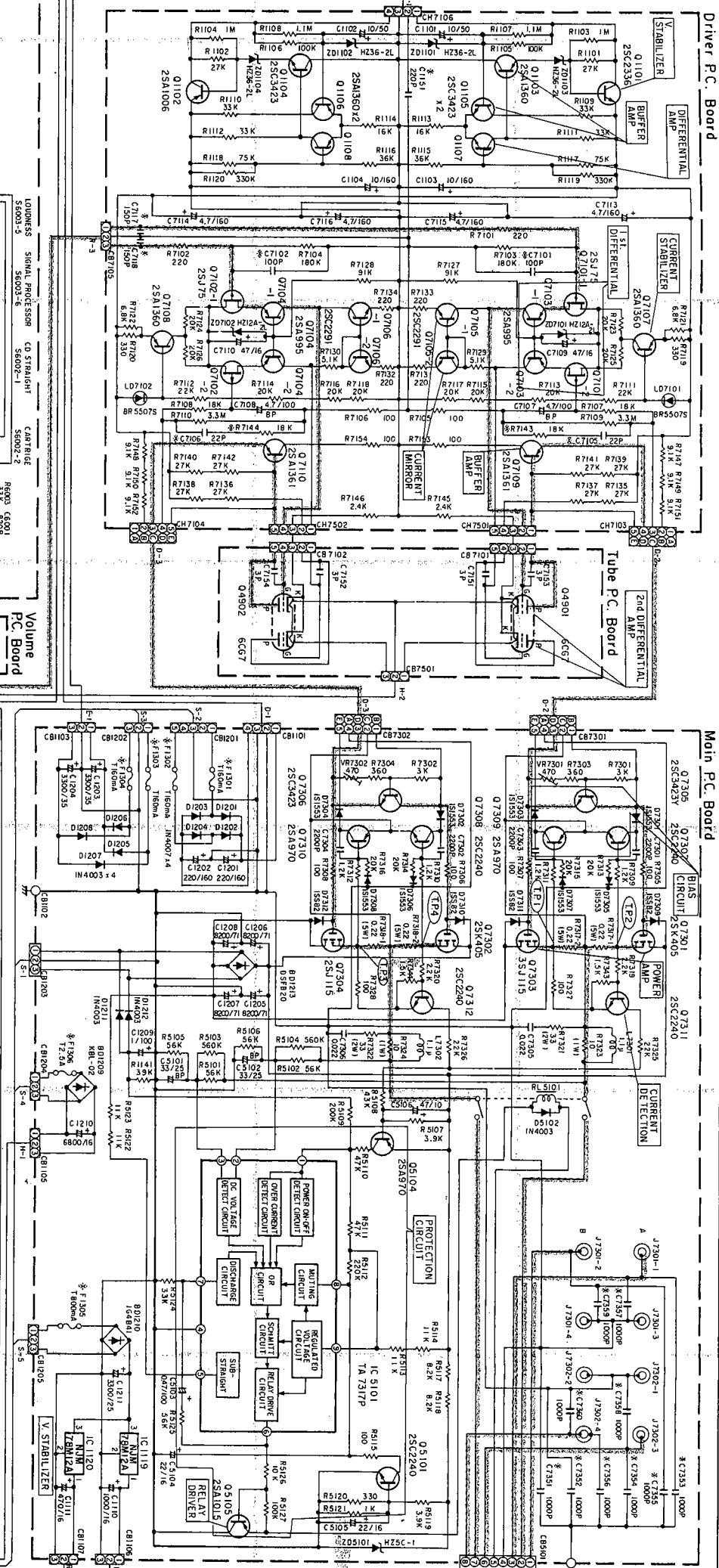

- NOTES:**
- All resistance values are in ohms. K = 1,000
 - All capacitance values are in microfarads. P = 1,000,000

Measuring Condition

1. Power Supply Voltage
AM model only: AC 220V
UN/UL model only: AC 120V

2. Measuring Meter
Digital Voltmeter

3. Measuring Point Reference
Between GND

4. Measuring Condition
No signal input

Point	Value	Point	Value
01011	6.2V	7V	7.7V
01012	7.7V	6.2V	5.5V
01013	128V	100.5V	95.9V
01014	128V	100.5V	95.9V
01015	0V	62.5V	63.1V
01016	0V	62.5V	63.1V
01017	0V	62.5V	63.1V
01018	62.5V	31.4V	36.8V
01019	62.5V	31.4V	36.8V
01020	62.5V	31.4V	36.8V
01021	62.5V	31.4V	36.8V
01022	62.5V	31.4V	36.8V
01023	62.5V	31.4V	36.8V
01024	62.5V	31.4V	36.8V
01025	62.5V	31.4V	36.8V
01026	62.5V	31.4V	36.8V
01027	62.5V	31.4V	36.8V
01028	62.5V	31.4V	36.8V
01029	62.5V	31.4V	36.8V
01030	62.5V	31.4V	36.8V
01031	62.5V	31.4V	36.8V
01032	62.5V	31.4V	36.8V
01033	62.5V	31.4V	36.8V
01034	62.5V	31.4V	36.8V
01035	62.5V	31.4V	36.8V
01036	62.5V	31.4V	36.8V
01037	62.5V	31.4V	36.8V
01038	62.5V	31.4V	36.8V
01039	62.5V	31.4V	36.8V
01040	62.5V	31.4V	36.8V
01041	62.5V	31.4V	36.8V
01042	62.5V	31.4V	36.8V
01043	62.5V	31.4V	36.8V
01044	62.5V	31.4V	36.8V
01045	62.5V	31.4V	36.8V
01046	62.5V	31.4V	36.8V
01047	62.5V	31.4V	36.8V
01048	62.5V	31.4V	36.8V
01049	62.5V	31.4V	36.8V
01050	62.5V	31.4V	36.8V
01051	62.5V	31.4V	36.8V
01052	62.5V	31.4V	36.8V
01053	62.5V	31.4V	36.8V
01054	62.5V	31.4V	36.8V
01055	62.5V	31.4V	36.8V
01056	62.5V	31.4V	36.8V
01057	62.5V	31.4V	36.8V
01058	62.5V	31.4V	36.8V
01059	62.5V	31.4V	36.8V
01060	62.5V	31.4V	36.8V
01061	62.5V	31.4V	36.8V
01062	62.5V	31.4V	36.8V
01063	62.5V	31.4V	36.8V
01064	62.5V	31.4V	36.8V
01065	62.5V	31.4V	36.8V
01066	62.5V	31.4V	36.8V
01067	62.5V	31.4V	36.8V
01068	62.5V	31.4V	36.8V
01069	62.5V	31.4V	36.8V
01070	62.5V	31.4V	36.8V
01071	62.5V	31.4V	36.8V
01072	62.5V	31.4V	36.8V
01073	62.5V	31.4V	36.8V
01074	62.5V	31.4V	36.8V
01075	62.5V	31.4V	36.8V
01076	62.5V	31.4V	36.8V
01077	62.5V	31.4V	36.8V
01078	62.5V	31.4V	36.8V
01079	62.5V	31.4V	36.8V
01080	62.5V	31.4V	36.8V
01081	62.5V	31.4V	36.8V
01082	62.5V	31.4V	36.8V
01083	62.5V	31.4V	36.8V
01084	62.5V	31.4V	36.8V
01085	62.5V	31.4V	36.8V
01086	62.5V	31.4V	36.8V
01087	62.5V	31.4V	36.8V
01088	62.5V	31.4V	36.8V
01089	62.5V	31.4V	36.8V
01090	62.5V	31.4V	36.8V
01091	62.5V	31.4V	36.8V
01092	62.5V	31.4V	36.8V
01093	62.5V	31.4V	36.8V
01094	62.5V	31.4V	36.8V
01095	62.5V	31.4V	36.8V
01096	62.5V	31.4V	36.8V
01097	62.5V	31.4V	36.8V
01098	62.5V	31.4V	36.8V
01099	62.5V	31.4V	36.8V
01100	62.5V	31.4V	36.8V

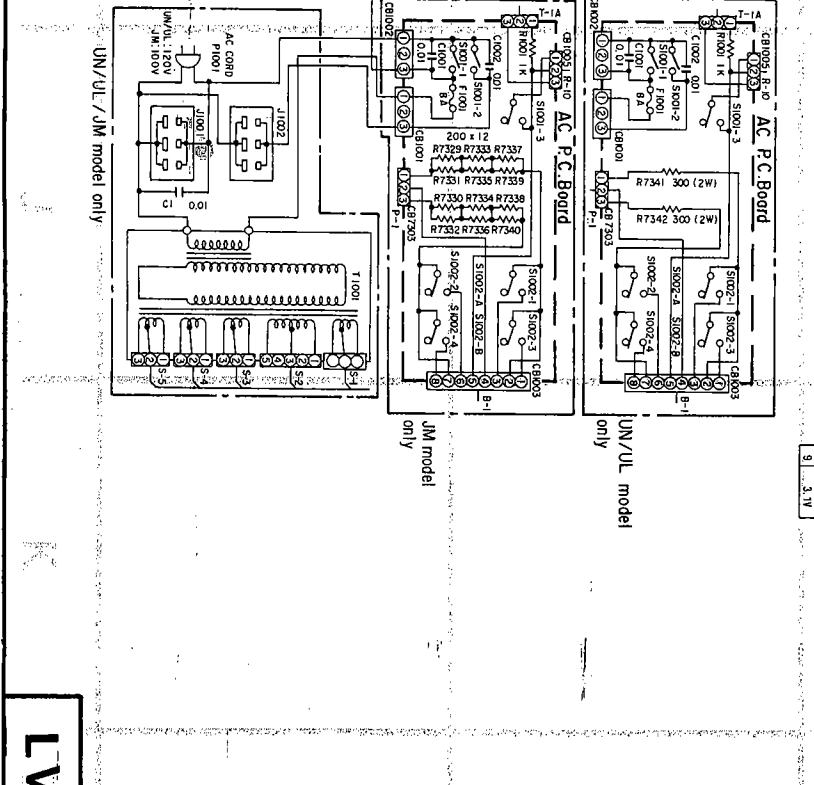

LV-105 u

Parts Layout on P.C. Boards and Wiring Diagram (1/3)

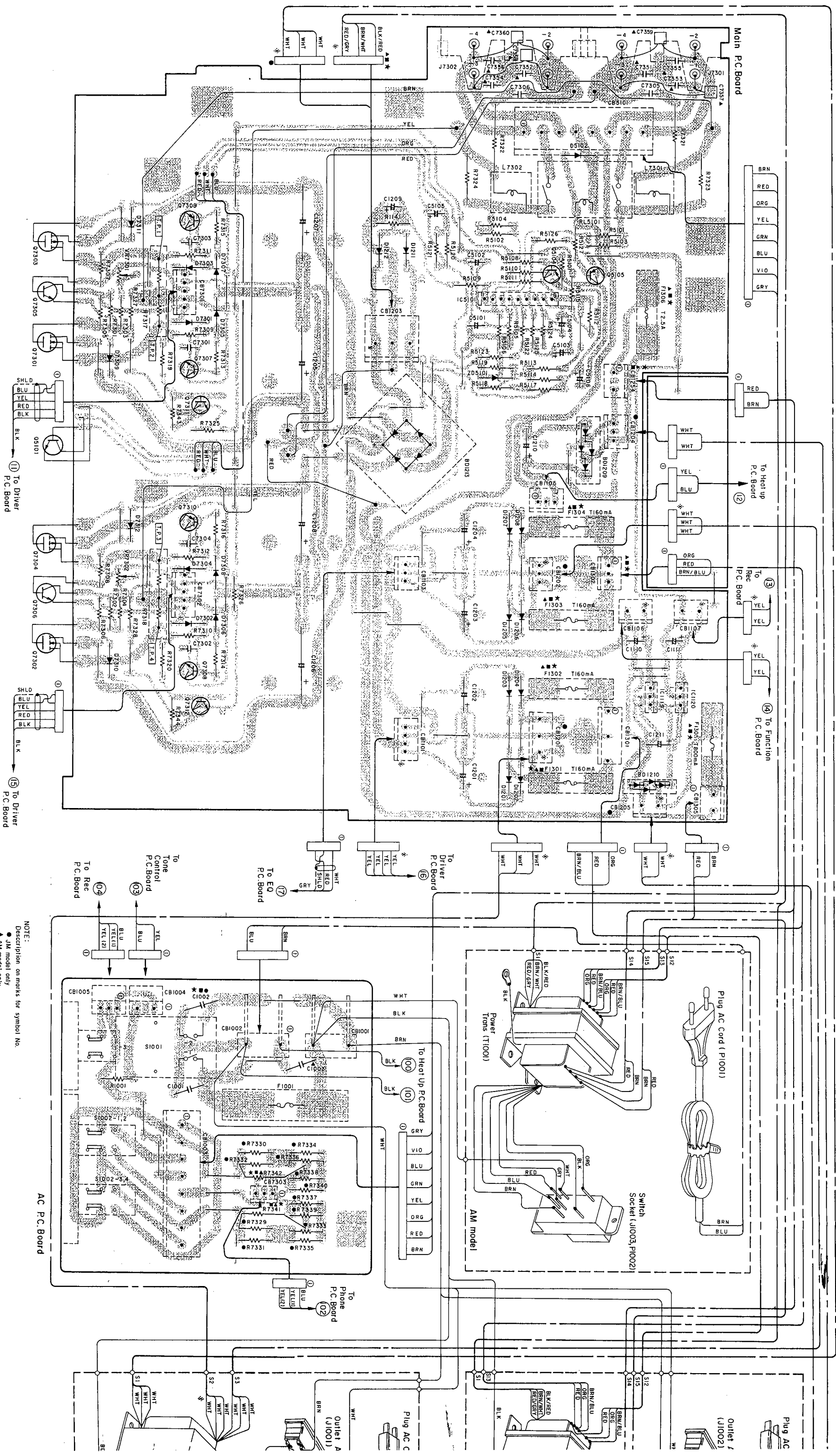

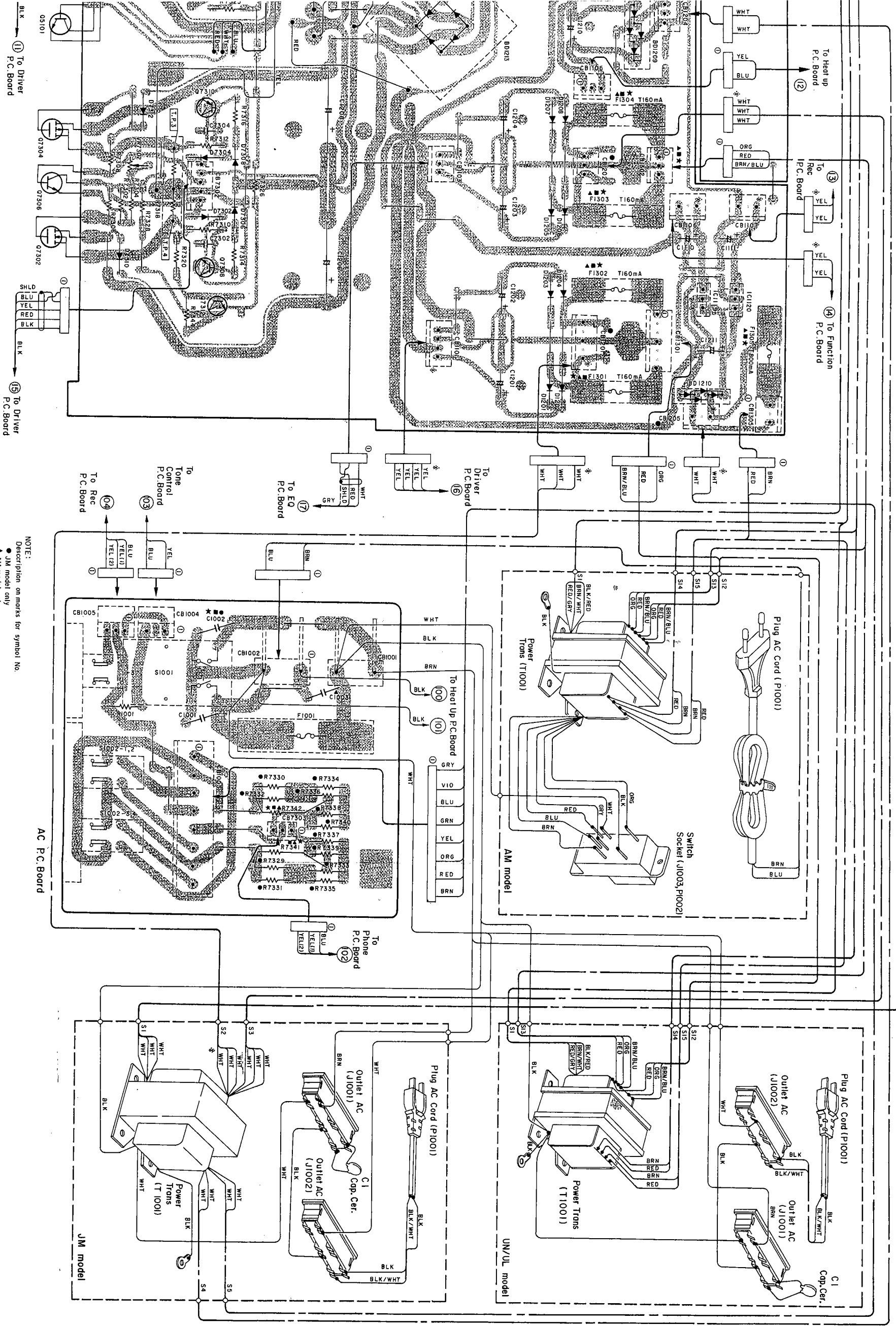

NOTE:
 Description on marks for symbol No.
 ● JM model only
 ▲ AM model only
 ■ UL model only
 ★ UN model only

- BLU Blue
- GRN Green
- BLK Black
- GRY Gray
- WHT White
- RED Red
- BRN Brown
- ORG Orange
- YEL Yellow
- VIO Violet
- PNK Pink
- GRN/WHT Green/White
- GRY/WHT Gray/White
- GRN/YEL Green/Yellow
- SHLD Shield

Parts Layout on P.C. Boards and Wiring Diagram (2/3)

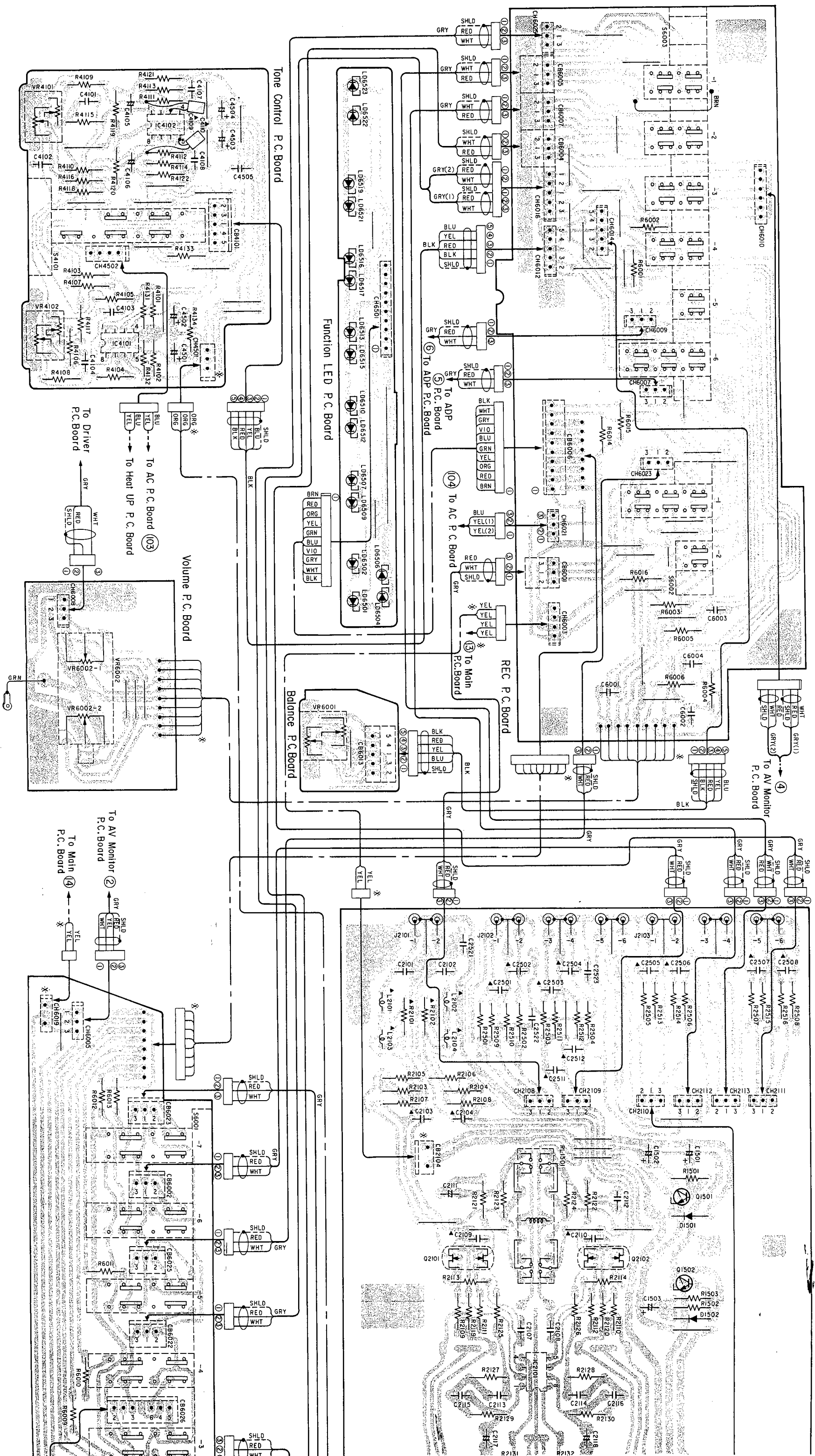

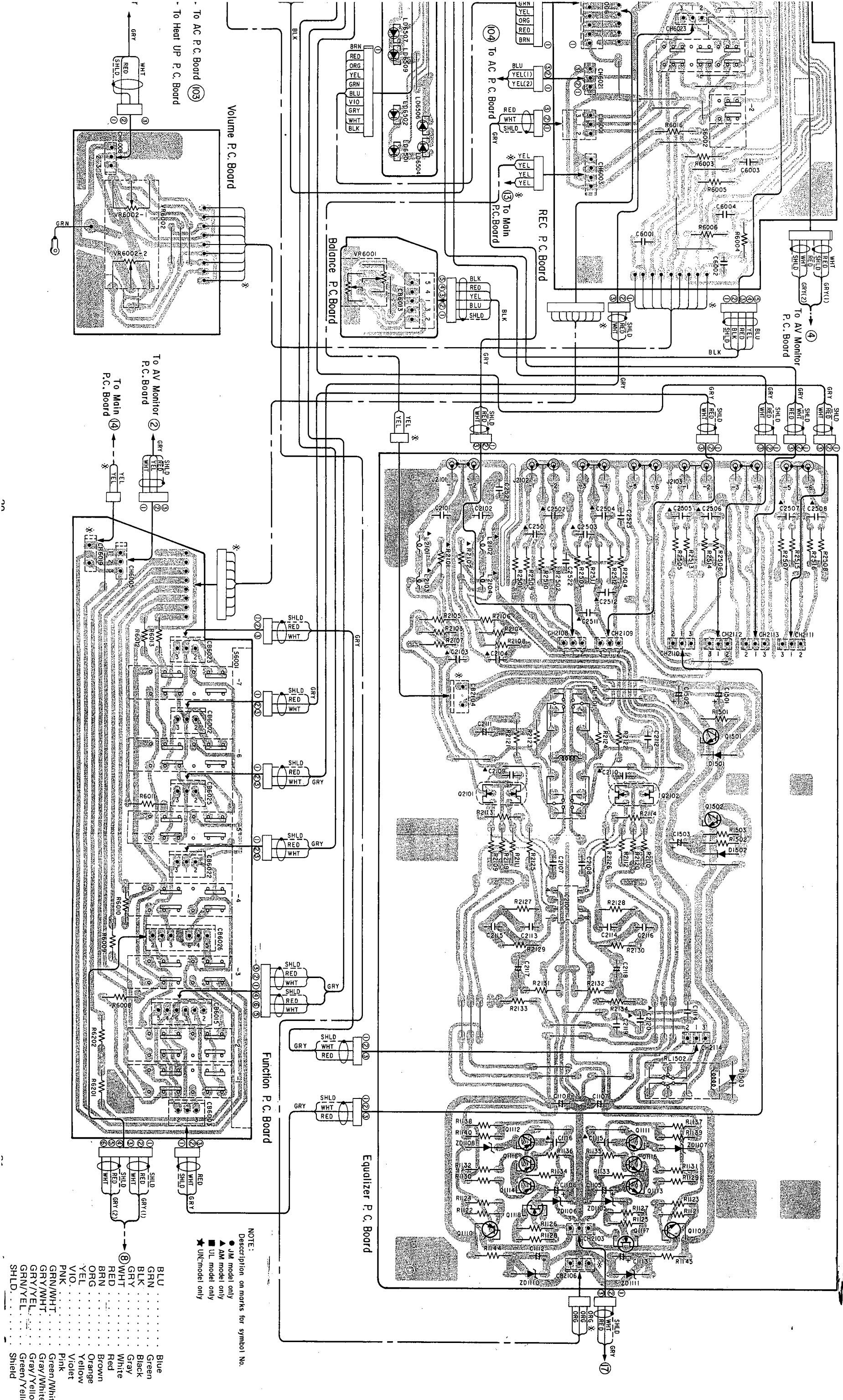

NOTE:
 Description on marks for symbol No.
 ● JM model only
 ▲ AM model only
 ■ UL model only
 ★ UN-model only

- BLU Blue
- GRN Green
- BLK Black
- GRY Gray
- WHT White
- RED Red
- BRN Brown
- ORG Orange
- YEL Yellow
- VIO Violet
- PNK Pink
- GRN/WHIT Green/White
- GRY/WHIT Gray/White
- GRY/YEL Gray/Yellow
- GRN/YEL Green/Yellow
- SHLD Shield

Electrical Parts List

Resistor : Carbon resistors under 1/4 watts are not mentioned in the parts list, please confirm them by schematic diagram.
 uF = microfarads, pF = picofarads

Abbreviations				
RES. = Resistor	CAP. = Capacitor			
C.F. = Carbon Film	ELY. = Electrolytic			
M.F. = Metal Film	CER. = Ceramic			
M.O. = Metal Oxide Film	MYL. = Mylar			
M.P. = Metal Plate	TAN. = Tantalum			
TR. = Transistor	POLY. = Polystyrol			
TRANS. = Transformer	PP. = Polypropylene			
CP. = Chip	PLT. = Polyethylene			
Symbol No.	Part No.	Description		
AC P. C. Board				
Switches				
● S1001	40T61963F02	Push SDU3P (Power)		
■ S1001	40T61963F02	Push SDU3P (Power)		
▲ S1001	40T68579F01	Push SDU3P (Power)		
★ S1001	40T61963F02	Push SDU3P (Power)		
S1002	40T67388F01	Push SUL231A (Speaker A, B)		
Capacitors				
C1001	08T57437F11	CER., 0.01 μ F		
● C1002	08T57437F11	CER., 0.01 μ F		
■ C1002	08T57437F11	CER., 0.01 μ F		
★ C1002	08T57437F11	CER., 0.01 μ F		
▲ C1003	08T57437F11	CER., 0.01 μ F		
Resistors				
▲ R7341	06T00007L52	M.O., 300 ohm 2W		
■ R7341	06T00007L52	M.O., 300 ohm 2W		
★ R7341	06T00007L52	M.O., 300 ohm 2W		
▲ R7342	06T00007L52	M.O., 300 ohm 2W		
■ R7342	06T00007L52	M.O., 300 ohm 2W		
★ R7342	06T00007L52	M.O., 300 ohm 2W		
Heat Up P. C. Board				
Transistor/Diodes				
Q1011	48T81102F01	TR., 2SA1015		
D1011	48T71195F01	1S1553		
D1012	48T71195F01	1S1553		
ZD1011	48T52739F31	Zener HZ5C-1		
Symbol No.	Part No.	Description		
Switches				
● S1011	40T81345F01	Power SDS2.5 (Pre-Heating)		
▲ S1011	40T81345F01	Power SDS2.5 (Pre-Heating)		
■ S1011	40T83288F01	Push SDDSA-3 (Pre-Heating)		
★ S1011	40T92612F01	Push SDDFA3 (Pre-Heating)		
Equalizer P. C. Board				
IC/Transistors				
IC2101	51T00038L01	M5220P		
Q1109	48T64376F01	TR., 2SC3423		
Q1110	48T64375F01	TR., 2SA1360		
Q1111	48T81102F01	TR., 2SA1015		
Q1112	48T81101F01	TR., 2SC1815		
Q1113	48T81101F01	TR., 2SC1815		
Q1114	48T81102F01	TR., 2SA1015		
Q1115	48T81101F01	TR., 2SC1815		
Q1116	48T81102F01	TR., 2SA1015		
Q1117	48T52152F01	FET, 2SK30A		
Q1118	48T52152F01	FET, 2SK30A		
Q1501	48T81101F01	TR., 2SC1815		
Q1502	48T81101F01	TR., 2SC1815		
Q2101	48T72887F02	FET, 2SK332		
Q2102	48T72887F02	FET, 2SK332		
Diodes				
D1501	48S40477U01	IN4003		
D1502	48T71195F01	1S1553		
D1503	48S40477U01	IN4003		
ZD1105	48T52741F03	Zener HZ6A-3L		
ZD1106	48T52741F03	Zener HZ6A-3L		
ZD1107	48T52741F03	Zener HZ6A-3L		
ZD1108	48T52741F03	Zener HZ6A-3L		
ZD1110	48T52741F51	Zener HZ16-3L		
ZD1111	48T52741F51	Zener HZ16-3L		

Notes : ● : For Japanese model only (JM), ▲ : For European model only (AM),
 ■ : For North American model only (UL), ★ : For Canadian model only (UN), Others : Common.

Symbol No.	Part No.	Description		
Inductors				
▲ L2101	24T83130F02	33 μ H		
▲ L2102	24T83130F02	33 μ H		
▲ L2103	24T83130F02	33 μ H		
▲ L2104	24T83130F02	33 μ H		
Relays				
RL1501	80T72831F01	G6A-434P-12VDC		
● RL1502	80T00048L01	RZ-12W		
■ RL1502	80T83717F02	DS2Y-S-DC12V		
▲ RL1502	80T83717F02	DS2Y-S-DC12V		
★ RL1502	80T83717F02	DS2Y-S-DC12V		
Jacks				
J2101-1	09T81363F01	Plate, Phone (Phono)		
J2101-2				
J2102-1	09T81364F01	Plate, Phone (CD, Tuner)		
J2102-6				
J2103-1	09T81364F01	Plate, Phone (Tape1, Tape2)		
J2103-6				
Capacitors				
C1105	23T00154L33	ELY., 10 μ F/50V		
C1106	23T00154L33	ELY., 10 μ F/50V		
C1107	23T00132L25	ELY., 47 μ F/50V		
C1108	23T00132L25	ELY., 47 μ F/50V		
C1112	23T00154L33	ELY., 10 μ F/50V		
C1113	23T00154L33	ELY., 10 μ F/50V		
C1114	08T57851F21	TF., 0.47 μ F		
▲ C1115	08T81196F34	Mica, 100pF		
▲ C1116	08T81196F34	Mica, 100pF		
● C1501	23T00138L22	ELY., 220 μ F/16V		
★ C1501	23T00138L21	ELY., 100 μ F/16V		
▲ C1501	23T00138L21	ELY., 100 μ F/16V		
■ C1501	23T00138L21	ELY., 100 μ F/16V		
C1502	23T00138L24	ELY., 470 μ F/16V		
C1503	23T00138L19	ELY., 33 μ F/16V		
C2101	08T61630F73	POLY., 100pF		
C2102	08T61630F73	POLY., 100pF		
▲ C2103	08T61630F26	POLY., 220pF		
▲ C2104	08T61630F26	POLY., 220pF		
C2107	08T00015L19	PP., 3300pF		

Symbol No.	Part No.	Description		
C2108	08T00015L19	PP., 3300pF		
▲ C2109	21S40655F20	CER., 56pF		
▲ C2110	21S40655F20	CER., 56pF		
C2111	23T00153L01	ELY., (B.P.) 1000 μ F/6.3V		
C2112	23T00153L01	ELY., (B.P.) 1000 μ F/6.3V		
C2113	08T00015L38	PP., 9100pF		
C2114	08T00015L38	PP., 9100pF		
C2115	08T71458F39	PP., 0.0318 μ F		
C2116	08T71458F39	PP., 0.0318 μ F		
C2117	23T61177F06	ELY., (B.P.) 4.7 μ F/100V		
C2118	23T61177F06	ELY., (B.P.) 4.7 μ F/100V		
▲ C2119	08T00015L18	PP., 2700pF		
▲ C2120	08T00015L18	PP., 2700pF		
▲ C2501	08T61630F34	POLY., 470pF		
▲ C2502	08T61630F34	POLY., 470pF		
▲ C2503	08S40805F05	CER., 470pF		
▲ C2504	08S40805F05	CER., 470pF		
▲ C2505	08S40805F05	CER., 470pF		
▲ C2506	08S40805F05	CER., 470pF		
▲ C2507	08S40805F05	CER., 470pF		
▲ C2508	08S40805F05	CER., 470pF		
▲ C2511	08S40805F05	CER., 470pF		
▲ C2512	08S40805F05	CER., 470pF		
▲ C2521	08T57851F24	TF., 1000pF		
● C2521	08T57851F21	TF., 0.47 μ F		
■ C2521	08T57851F21	TF., 0.47 μ F		
★ C2521	08T57851F21	TF., 0.47 μ F		
C2522	08T57851F21	TF., 0.47 μ F		
C2523	08T57851F21	TF., 0.47 μ F		
Resistors				
R2133	06T00147L57	C.F., 470 ohm 1/2W		
R2134	06T00147L57	C.F., 470 ohm 1/2W		
R2501	06T00147L41	C.F., 100 ohm 1/2W		
R2502	06T00147L41	C.F., 100 ohm 1/2W		
Driver P. C. Board				
Transistors				
Q1101	48T62642F01	2SC2336		
Q1102	48T62641F01	2SA1006		
Q1103	48T64375F01	2SA1360		
Q1104	48T64376F01	2SC3423		
Q1105	48T64376F01	2SC3423		

Notes : ● : For Japanese model only (JM), ▲ : For European model only (A11),
 ■ : For North American model only (UL), ★ : For Canadian model only (UN), Others : Common.

Symbol No.	Part No.	Description		
Q1106	48T64375F01	2SA1360		
Q1107	48T64376F01	2SC3423		
Q1108	48T64375F01	2SA1360		
Q7101	48T62284F02	FET, 2SJ75		
Q7102	48T62284F02	FET, 2SJ75		
Q7103	48T72597F01	2SA995		
Q7104	48T72597F01	2SA995		
Q7105	48T72598F01	2SC2291		
Q7106	48T72598F01	2SC2291		
Q7107	48T64375F01	2SA1360		
Q7108	48T64375F01	2SA1360		
Q7109	48T71448F01	2SA1361		
Q7110	48T71448F01	2SA1361		
Diodes/LEDs				
LD7101	48T52953F03	LED BR5507S (RED)		
LD7102	48T52953F03	LED BR5507S (RED)		
ZD1101	48T52741F74	Zener HZ36-2L		
ZD1102	48T52741F74	Zener HZ36-2L		
ZD1103	48T52741F74	Zener HZ36-2L		
ZD1104	48T52741F74	Zener HZ36-2L		
ZD7101	48T52741F38	Zener HZ12A-2L		
ZD7102	48T52741F38	Zener HZ12A-2L		
Capacitors				
C1101	23T00154L33	ELY., 10 μ F/50V		
C1102	23T00154L33	ELY., 10 μ F/50V		
C1103	23T00138L86	ELY., 10 μ F/160V		
C1104	23T00138L86	ELY., 10 μ F/160V		
▲ C1151	08T81196F42	Mica, 220pF		
● C7101	08T00125L04	POLY., 100pF		
■ C7101	08T00125L04	POLY., 100pF		
★ C7101	08T00125L04	POLY., 100pF		
● C7102	08T00125L04	POLY., 100pF		
■ C7102	08T00125L04	POLY., 100pF		
★ C7102	08T00125L04	POLY., 100pF		
▲ C7105	08T61642F12	Mica, 22pF		
▲ C7106	08T61642F12	Mica, 22pF		
C7107	23T61177F06	ELY., (B.P.) 4.7 μ F/100V		
C7108	23T61177F06	ELY., (B.P.) 4.7 μ F/100V		
C7109	23T00154L12	ELY., 47 μ F/16V		
C7110	23T00154L12	ELY., 47 μ F/16V		
C7113	23T00138L85	ELY., 4.7 μ F/160V		
C7114	23T00138L85	ELY., 4.7 μ F/160V		
C7115	23T00138L85	ELY., 4.7 μ F/160V		

Symbol No.	Part No.	Description		
C7116	23T00138L85	ELY., 4.7 μ F/160V		
▲ C7117	08T61630F22	POLY., 150pF		
▲ C7118	08T61630F22	POLY., 150pF		
Resistors : (All resistors are carbon film 1/2W \pm 5% unless otherwise noted.)				
R7101	06T00147L49	220 ohm		
R7102	06T00147L49	220 ohm		
R7103	06T00148L20	180K ohm		
R7104	06T00148L20	180K ohm		
R7105	06T00147L41	100 ohm		
R7106	06T00147L41	100 ohm		
R7107	06T00147L95	18K ohm		
R7108	06T00147L95	18K ohm		
R7109	06T00148L50	3.3M ohm		
R7110	06T00148L50	3.3M ohm		
R7153	06T69013F41	Fuse 100 ohm 1/4W		
R7154	06T69013F41	Fuse 100 ohm 1/4W		
Main P. C. Board				
IC's				
IC1119	51T72375F01	NJM78M12A		
IC1120	51T72375F01	NJM78M12A		
IC5101	51T67437F01	TA7317P		
Transistors				
Q5104	48T52545F02	2SA970		
Q5105	48T81102F01	2SA1015		
Q7307	48T53301F02	2SC2240		
Q7308	48T53301F02	2SC2240		
Q7309	48T52545F02	2SA970		
Q7310	48T52545F02	2SA970		
Q7311	48T53301F02	2SC2240		
Q7312	48T53301F02	2SC2240		
Diodes				
D1201	48S40477U07	IN4007		
D1202	48S40477U07	IN4007		
D1203	48S40477U07	IN4007		
D1204	48S40477U07	IN4007		
D1205	48S40477U01	IN4003		

Notes : ● : For Japanese model only (JM), ▲ : For European model only (AM),
 ■ : For North American model only (UL), ★ : For Canadian model only (UN), Others : Common.

Symbol No.	Part No.	Description			Symbol No.	Part No.	Description		
D1206	48S40477U01	IN4003			▲ C1202	23T00142L40	ELY., 220 μ F/160V		
D1207	48S40477U01	IN4003			■ C1202	23T00142L40	ELY., 220 μ F/160V		
D1208	48S40477U01	IN4003			★ C1202	23T00142L40	ELY., 220 μ F/160V		
D1211	48S40477U01	IN4003			● C1203	23T00142L17	ELY., 3300 μ F/35V		
D1212	48S40477U01	IN4003			▲ C1203	23T00142L39	ELY., 3300 μ F/35V		
D5102	48S40477U01	IN4003			■ C1203	23T00142L39	ELY., 3300 μ F/35V		
D7301	48T71195F01	1S1553			★ C1203	23T00142L39	ELY., 3300 μ F/35V		
D7302	48T71195F01	1S1553			● C1204	23T00142L17	ELY., 3300 μ F/35V		
D7303	48T71195F01	1S1553			▲ C1204	23T00142L39	ELY., 3300 μ F/35V		
D7304	48T71195F01	1S1553			■ C1204	23T00142L39	ELY., 3300 μ F/35V		
D7305	48T71195F01	1S1553			★ C1204	23T00142L39	ELY., 3300 μ F/35V		
D7306	48T71195F01	1S1553			C1205	23T00022L05	ELY., 8200 μ F/71V		
D7307	48T71195F01	1S1553			C1206	23T00022L05	ELY., 8200 μ F/71V		
D7308	48T71195F01	1S1553			C1207	23T00022L05	ELY., 8200 μ F/71V		
D7309	48T73079F02	ISS82			C1208	23T00022L05	ELY., 8200 μ F/71V		
D7310	48T73079F02	ISS82			C1209	23T00138L72	ELY., 1 μ F/100V		
D7311	48T73079F02	ISS82			● C1210	23T00142L08	ELY., 6800 μ F/16V		
D7312	48T73079F02	ISS82			▲ C1210	23T00142L38	ELY., 6800 μ F/16V		
ZD5101	48T52739F31	Zener HZ5C-1			■ C1210	23T00142L38	ELY., 6800 μ F/16V		
BD1213	48T67435F01	Bridge, D5FD20			★ C1210	23T00142L38	ELY., 6800 μ F/16V		
BD1209	48T71451F01	Bridge, KBL-02			● C1211	23T00137L44	ELY., 3300 μ F/25V		
BD1210	48T61415F03	Bridge, 1G4B41			▲ C1211	23T00137L48	ELY., 3300 μ F/25V		
Coils/Relay					■ C1211	23T00137L48	ELY., 3300 μ F/25V		
L7301	24T74614F01	Inductor 1.1 μ H			★ C1211	23T00137L48	ELY., 3300 μ F/25V		
L7302	24T74614F01	Inductor 1.1 μ H			C5101	23T00140L25	ELY., (B.P.) 33 μ F/25V		
RL5101	80T53350F01	Relay, G2Z-222P-US			C5102	23T00140L25	ELY., (B.P.) 33 μ F/25V		
Jacks					C5103	23T00138L71	ELY., 0.47 μ F/100V		
J7301	09T81893F02	Terminal SP T5957L			C5104	23T00138L18	ELY., 22 μ F/16V		
J7302	09T81893F01	Terminal SP T5957			C5105	23T00138L18	ELY., 22 μ F/16V		
Capacitors					C5106	23T00138L11	ELY., 47 μ F/10V		
● C1110	23T00136L33	ELY., 1000 μ F/16V			C7301	08T00015L17	PP., 2200pF		
▲ C1110	23T00137L49	ELY., 1000 μ F/16V			C7302	08T00015L17	PP., 2200pF		
■ C1110	23T00137L49	ELY., 1000 μ F/16V			C7303	08T00015L17	PP., 2200pF		
★ C1110	23T00137L49	ELY., 1000 μ F/16V			C7304	08T00015L17	PP., 2200pF		
C1111	23T00138L24	ELY., 470 μ F/16V			C7305	08T00015L29	PP., 0.022 μ F		
● C1201	23T00142L36	ELY., 220 μ F/160V			C7306	08T00015L29	PP., 0.022 μ F		
▲ C1201	23T00142L40	ELY., 220 μ F/160V			▲ C7351	08T57851F24	TF., 1000pF		
■ C1201	23T00142L40	ELY., 220 μ F/160V			▲ C7352	08T57851F24	TF., 1000pF		
★ C1201	23T00142L40	ELY., 220 μ F/160V			▲ C7353	08T57851F24	TF., 1000pF		
● C1202	23T00142L36	ELY., 220 μ F/160V			▲ C7354	08T57851F24	TF., 1000pF		
					▲ C7355	08T57851F24	TF., 1000pF		
					▲ C7356	08T57851F24	TF., 1000pF		
					▲ C7357	08T50579F26	TF., 1000pF		
					▲ C7358	08T50579F26	TF., 1000pF		
					▲ C7359	08T50579F26	TF., 1000pF		
					▲ C7360	08T50579F26	TF., 1000pF		

Notes: ● : For Japanese model only (JM), ▲ : For European model only (AM),
 ■ : For North American model only (UL), ★ : For Canadian model only (UN), Others : Common.

Symbol No.	Part No.	Description			Symbol No.	Part No.	Description		
Resistors					Capacitors				
R7305	06T69013F41	Fuse 100 ohm 1/4W			C3001	23S57007F15	ELY., 47 μ F/16V		
R7306	06T69013F41	Fuse 100 ohm 1/4W			C3002	23S57007F15	ELY., 47 μ F/16V		
R7307	06T69013F41	Fuse 100 ohm 1/4W			C3003	23S57007F09	ELY., 10 μ F/16V		
R7308	06T69013F41	Fuse 100 ohm 1/4W			C3004	23S40657F62	ELY., 470 μ F/16V		
R7317	06T67397F01	M.P. 0.22 ohm			C3005	23S40657F62	ELY., 470 μ F/16V		
R7318	06T67397F01	M.P. 0.22 ohm			C3006	23S40657F62	ELY., 470 μ F/16V		
R7321	06T00007L29	M.O., 33 ohm 2W			▲ C3009	08S40805F05	CER., 470pF		
R7322	06T00007L29	M.O., 33 ohm 2W			▲ C3010	08S40805F05	CER., 470pF		
R7323	06T00005L17	M.O., 10 ohm 1W			▲ C3013	08S40805F05	CER., 470pF		
R7324	06T00005L17	M.O., 10 ohm 1W			▲ C3014	08S40805F05	CER., 470pF		
VR7301	18B44064J01	Variable, 470 ohm B 1/2W			C3019	23S57007F09	ELY., 10 μ F/16V		
VR7302	18B44064J01	Variable, 470 ohm B 1/2W			C3023	23S40657F62	ELY., 470 μ F/16V		
AV Monitor P. C. Board					Tone Control P. C. Board				
IC/Transistors					IC's/Switch				
IC3001	51T80995F01	M51320P			IC4101	51T80136F01	M5238P		
Q3001	48T81101F01	TR., 2SC1815			IC4102	51T52383F01	NJM4558D		
Q3002	48T81101F01	TR., 2SC1815			S4101	40T81347F01	Switch, Push SUL122A (Tone In)		
Q3003	48T81101F01	TR., 2SC1815							
● Q3004	48T81101F01	TR., 2SC1815							
▲ Q3004	48S43525F05	TR., 2SC1815							
■ Q3004	48S43525F05	TR., 2SC1815							
★ Q3004	48S43525F05	TR., 2SC1815							
Diodes/Relays					Capacitors				
D3001	48T71195F01	1S1553			C4101	08T57851F12	TF., 0.082 μ F		
D3002	48T71195F01	1S1553			C4102	08T57851F12	TF., 0.082 μ F		
RL3001	80T73804F02	Relay, FBR42NG012-P			C4103	08T52448F29	P.P., 4700pF		
RL3002	80T82335F01	Relay, G2E-1645A			C4104	08T52448F29	P.P., 4700pF		
					C4105	23T00140L37	ELY., (B.P.) 2.2 μ F/50V		
					C4106	23T00140L37	ELY., (B.P.) 2.2 μ F/50V		
					C4107	08T52448F35	PP., 8200pF		
					C4108	08T52448F35	PP., 8200pF		
					▲ C4109	08T61642F27	Mica, 100pF		
					▲ C4110	08T61642F27	Mica, 100pF		
					C4501	23T00138L26	ELY., 4.7 μ F/25V		
					C4502	23T00138L26	ELY., 4.7 μ F/25V		
					C4503	23T00138L26	ELY., 4.7 μ F/25V		
					C4504	23T00138L26	ELY., 4.7 μ F/25V		
					C4505	08T57851F21	TF., 0.47 μ F		
Jacks					Volumes				
J3001	09T81368F01	Plate, Phone (AV1, AV2)			VR4101	18T67394F01	Control, 10KB×2 (BASS)		
J3002	09T81367F01	Plate, Phone (AV1, AV2)			VR4102	18T67394F01	Control, 10KB×2 (TREBLE)		
J3003	09T81370F01	Plate, Phone (MONITOR)							

Notes: ● : For Japanese model only (JM), ▲ : For European model only (AM),
 ■ : For North American model only (UL), ★ : For Canadian model only (UN), Others : Common.

Symbol No.	Part No.	Description		
Function LED P. C. Board				
LED's				
LD6501	48T60947F04	SLH-34MG3F (GRN)		
LD6502	48T60947F04	SLH-34MG3F (GRN)		
LD6504	48T60947F05	SLH-34VR3F (RED)		
LD6506	48T60947F05	SLH-34VR3F (RED)		
LD6507	48T60947F04	SLH-34MG3F (GRN)		
LD6509	48T60947F04	SLH-34MG3F (GRN)		
LD6510	48T60947F04	SLH-34MG3F (GRN)		
LD6512	48T60947F04	SLH-34MG3F (GRN)		
LD6513	48T60947F04	SLH-34MG3F (GRN)		
LD6515	48T60947F04	SLH-34MG3F (GRN)		
LD6516	48T60947F04	SLH-34MG3F (GRN)		
LD6517	48T60947F04	SLH-34MG3F (GRN)		
LD6519	48T60947F04	SLH-34MG3F (GRN)		
LD6521	48T60947F04	SLH-34MG3F (GRN)		
LD6522	48T60947F05	SLH-34VR3F (RED)		
LD6523	48T60947F05	SLH-34VR3F (RED)		
AV Front P. C. Board				
Switch/Jacks				
S6007	40T81346F01	Switch, Push SUL121A (AV-2)		
J9501	09T67396F01	Plate, Phone (AV2, L)		
J9502	09T67396F01	Plate, Phone (AV2, R)		
J9503	09T67396F01	Plate, Phone (AV2, V)		
Capacitors				
	C6202	23T00138L49	ELY., 10 μ F/50V	
▲	C9501	08S40805F05	CER., 470pF	
▲	C9502	08S40805F05	CER., 470pF	
	C9505	08T57851F21	TF., 0.47 μ F	
	C9506	08T57851F21	TF., 0.47 μ F	

Symbol No.	Part No.	Description		
Function P. C. Board				
Switches				
S6001-1	40T81348F01	Push SUL702A (Monitor-1, 2, AV-1, 2 CD, Tuner, Phono)		
S6001-7				
Rec P. C. Board				
Switches				
S6002-1	40T82248F01	Push Spec 2 (CD Straight, Cartrige)		
S6002-2				
S6003-1	40T81349F01	Push Spec (Source, Tape2→1, AV2→1 Mode, Loud, Signal Prossesor)		
S6003-6				
Capacitors				
	C6001	08T52448F11	PP., 820pF	
	C6002	08T52448F11	PP., 820pF	
	● C6003	08T52448F41	PP., 0.015 μ F	
	■ C6003	08T57851F03	TF., 0.015 μ F	
	▲ C6003	08T57851F03	TF., 0.015 μ F	
	★ C6003	08T57851F03	TF., 0.015 μ F	
	● C6004	08T52448F41	PP., 0.015 μ F	
	■ C6004	08T57851F03	TF., 0.015 μ F	
	▲ C6004	08T57851F03	TF., 0.015 μ F	
	★ C6004	08T57851F03	TF., 0.015 μ F	
Tube P. C. Board				
Capacitors				
	C7151	08T81196F03	Mica, 3pF	
	C7152	08T81196F03	Mica, 3pF	
	C7153	08T81196F03	Mica, 3pF	
	C7154	08T81196F03	Mica, 3pF	

Notes : ● : For Japanese model only (JM), ▲ : For European model only (AM),
 ■ : For North American model only (UL), ★ : For Canadian model only (UN), Others : Common.

Cabinet Assembly Parts List

Note : Parts without part number are not supplied.

Symbol No.	Index	Part No.	Description	Symbol No.	Index	Part No.	Description
	1	5-A 01B81332F01	Assy., Escutcheon Knob	36		75A67064F01	Felt
	3	1-A 15D67323F01	Cover, Top	37		03S44205G28	Screw, Bind (M4×16)
●	7	2-H 15C81265F01	Cover, Rear	38		03A82468F01	Screw, Bind (M3×10)
■	7	2-H 15C81265F05	Cover, Rear	39		03S40018G08	Screw, Tapping (M3×8)
▲	7	2-H 15C81265F03	Cover, Rear	40		03S71031F04	Screw, Bind (M3×8)
★	7	2-H 15C81265F07	Cover, Rear	41		03S40036U01	Screw, W/ Washer (M4×8)
	8	3-B 36A67330F01	Knob, Power	42	3-A	04S40070G23	Washer, Flat (M3.3)
	9	3-B 36A67331F01	Knob, Push (SP)	43	2-E	75A82303F01	Cushion, Rubber
	10	4-C 36A81266F01	Knob, Push	45	6-A	03S40012G98	Screw, Countersink (M3×8)
	11	36A67333F01	Knob, Push	46	3-G	03C40121T18	Screw, W/Double Washer (M3×10)
	12	4-C 36A67334F01	Knob, Push (AV)	47	3-A	03S71031F05	Screw, Countersink (M3×8)
	13	4-A 36B67336F01	Knob, Main Volume	48	2-A	75S72374F70	Cushion, Rubber
	14	6-A 36A67337F01	Knob, Tone Volume	49	5-B	07B67320F01	Frame, LED
	15	4-C 43A67342F01	Spacer, Switch	50	5-A	14S58462F59	Insulator, Cover
	16	07A81270F01	Bracket., Volt	51	3-F	09T64527F02	Socket, Tube 9Pin
	17	3-H 07R51146F01	Support, TR	52		14S81481F12	Insulator, Cover
	18	1-H 29T66964F01	Terminal, GND	53		41A68570F01	Spring, Volume
	19	1-G 43B41625J02	Support, Cord	54	2-H	28T51067F01	Plug, Short Phono
●	20	2-F 43T53136F01	Bush, Cap.	55	5-B	01V81600F19	Assy., Function LED P.C.B
■	20	2-F 43T53136F01	Bush, Cap.	●	68	4-A 01V81600F58	Assy., Front Panel
★	20	2-F 43T53136F01	Bush, Cap.	■	68	4-A 01V83600F76	Assy., Front Panel
	21	29A41814G01	Lug	▲	68	4-A 01V83600F76	Assy., Front Panel
	22	03D40014G04	Screw, W/ Washer (M3×6)	★	68	4-A 01V83600F76	Assy., Front Panel
	23	03C40121T17	Screw, W/ Double Washer (M3×8)	70	3-E	47A81445F01	Shaft, Panel
	24	07C67319F01	Frame, Tube	79	4-E	84D81371F13	Assy., Balance P. C. Board
	25	29C41045P05	Lug, Wrap 54mm	80	4-E	84D81371F09	Panel, AV Front Hold
●	26	54B62266F36	Label, Fuse 8A-125V	■	81	4-E 54B62266F49	Label, Fuse
■	26	54B62266F53	Label, Fuse	■	82	54B62266F50	Label, Fuse
▲	26	54B62266F54	Label, Fuse	■	83	4-F 54B62266F51	Label, Fuse
★	26	54B62266F53	Label, Fuse	▲	84	09T45548F01	Holder, Fuse
	27	3-E 47A82105F01	Shaft, PCB	★	84	3-C 09T45548F01	Holder, Fuse
	28	4-C 15A69033F01	Guide, Volume	■	84	09T45548F01	Holder, Fuse
	29	3-F 75A67341F01	Cushion, Tube	▲	85	3-F 14A83125F01	Insulator SP Terminal "B"
●	31	3-C 09T51960F01	Holder, Fuse				
■	31	3-C 09T51960F01	Holder, Fuse				
★	31	3-C 09T51960F01	Holder, Fuse				
	32	29C41045P06	Lug, Board-In 50mm				
	33	4-H 75A82703F01	Cushion, Rubber				
	34	4-D 14S58462F12	Insulator, Cover				
	35	75A67063F03	Trann-Leg				

Notes : ● : For Japanese model only (JM), ▲ : For European model only (AM),
■ : For North American model only (UL), ★ : For Canadian model only (UN), Others : Common.

Packing Assembly Parts List

Symbol No.	Part No.	Description	Symbol No.	Part No.	Description
101-1	68P80130F59	Owners, Manual 103JM	▲ 103	56S71001F90	Carton, Packing
101-1	68P81707F59	Owners, Manual 103AM	■ 103	56S71001F90	Carton, Packing
101-1	68P81707F58	Owners, Manual 103UR	★ 104	56B40442T17	Packing, Front Frame
101-1	68P81707F59	Owners, Manual 103UR	105	56B40230G08	Sack, Polyethylene
102	56D67465F01	Packing, Tray	106	56A82796F01	Pad, Cushion
103	56S71001F74	Carton, Packing			

▲ : For Japanese model only (JM), ■ : For European model only (AM), ★ : For Canadian model only (UN), Others : Common.

Packing Method View

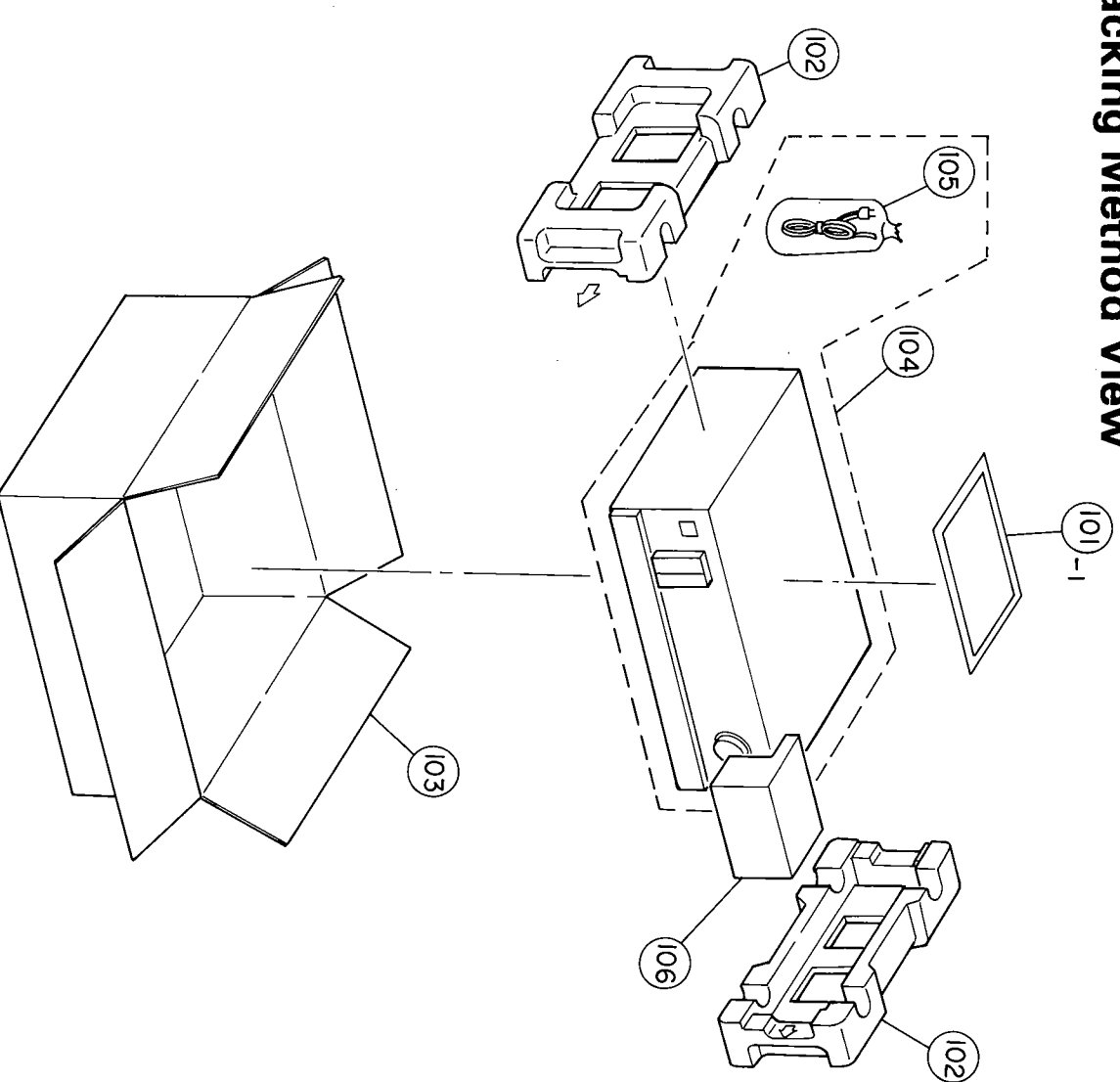

Parts List by the Destination

Symbol No.	Description	POWER SOURCE			
		JM ● 100V Japanese	UL ■ 120V North American	AM ▲ 220V European	UN ★ 120V Canadian
C1	Capacitor	08T57437F11 08T57437F11	08T57437F11 08T57437F11	Not Used Not Used	08T57437F11 08T57437F11
C1002	Capacitor	Not Used	Not Used	08T57437F11	Not Used
C1003	Capacitor	23T00136L33	23T00137L49	23T00137L49	23T00137L49
C1110	Capacitor	Not Used	Not Used	08T81196F34	Not Used
C1115	Capacitor	Not Used	Not Used	08T81196F34	Not Used
C1116	Capacitor	Not Used	Not Used	08T81196F34	Not Used
C1151	Capacitor	Not Used	Not Used	08T81196F42	Not Used
C1201	Capacitor	23T00142L36	23T00142L40	23T00142L40	23T00142L40
C1202	Capacitor	23T00142L36	23T00142L40	23T00142L40	23T00142L40
C1203	Capacitor	23T00142L17	23T00142L39	23T00142L39	23T00142L39
C1204	Capacitor	23T00142L17	23T00142L39	23T00142L39	23T00142L39
C1210	Capacitor	23T00142L08	23T00142L38	23T00142L38	23T00142L38
C1211	Capacitor	23T00137L44	23T00137L48	23T00137L48	23T00137L48
C1501	Capacitor	23T00138L22	23T00138L21	23T00138L21	23T00138L21
C2103	Capacitor	Not Used	Not Used	08T61630F26	Not Used
C2104	Capacitor	Not Used	Not Used	08T61630F26	Not Used
C2109	Capacitor	Not Used	Not Used	21S40655F20	Not Used
C2110	Capacitor	Not Used	Not Used	21S40655F20	Not Used
C2119	Capacitor	Not Used	Not Used	08T00015L18	Not Used
C2120	Capacitor	Not Used	Not Used	08T00015L18	Not Used
C2501	Capacitor	Not Used	Not Used	08T61630F34	Not Used
C2502	Capacitor	Not Used	Not Used	08T61630F34	Not Used
C2503	Capacitor	Not Used	Not Used	08S40805F05	Not Used
C2504	Capacitor	Not Used	Not Used	08S40805F05	Not Used
C2505	Capacitor	Not Used	Not Used	08S40805F05	Not Used
C2506	Capacitor	Not Used	Not Used	08S40805F05	Not Used
C2507	Capacitor	Not Used	Not Used	08S40805F05	Not Used
C2508	Capacitor	Not Used	Not Used	08S40805F05	Not Used
C2511	Capacitor	Not Used	Not Used	08S40805F05	Not Used
C2512	Capacitor	Not Used	Not Used	08S40805F05	Not Used
C2521	Capacitor	08T57851F21	08T57851F21	08T57851F24	08T57851F21
C3009	Capacitor	Not Used	Not Used	08S40805F05	Not Used
C3010	Capacitor	Not Used	Not Used	08S40805F05	Not Used
C3013	Capacitor	Not Used	Not Used	08S40805F05	Not Used
C3014	Capacitor	Not Used	Not Used	08S40805F05	Not Used
C4109	Capacitor	Not Used	Not Used	08T61642F27	Not Used
C4110	Capacitor	Not Used	Not Used	08T61642F27	Not Used
C6003	Capacitor	08T52448F41	08T57851F03	08T57851F03	08T57851F03
C6004	Capacitor	08T52448F41	08T57851F03	08T57851F03	08T57851F03
C7101	Capacitor	08T00125L04	08T00125L04	Not Used	08T00125L04
C7102	Capacitor	08T00125L04	08T00125L04	Not Used	08T00125L04
C7105	Capacitor	Not Used	Not Used	08T61642F12	Not Used
C7106	Capacitor	Not Used	Not Used	08T61642F12	Not Used
C7117	Capacitor	Not Used	Not Used	08T61630F22	Not Used
C7118	Capacitor	Not Used	Not Used	08T61630F22	Not Used

Symbol No.	Description	POWER SOURCE			
		JM ● 100V Japanese	UL ■ 120V North American	AM ▲ 220V European	UN ★ 120V Canadian
C7351	Capacitor	Not Used	Not Used	08T57851F24	Not Used
C7352	Capacitor	Not Used	Not Used	08T57851F24	Not Used
C7353	Capacitor	Not Used	Not Used	08T57851F24	Not Used
C7354	Capacitor	Not Used	Not Used	08T57851F24	Not Used
C7355	Capacitor	Not Used	Not Used	08T57851F24	Not Used
C7356	Capacitor	Not Used	Not Used	08T57851F24	Not Used
C7357	Capacitor	Not Used	Not Used	08T50579F26	Not Used
C7358	Capacitor	Not Used	Not Used	08T50579F26	Not Used
C7359	Capacitor	Not Used	Not Used	08T50579F26	Not Used
C7360	Capacitor	Not Used	Not Used	08T50579F26	Not Used
C9001	Capacitor	Not Used	Not Used	08S40805F05	Not Used
C9002	Capacitor	Not Used	Not Used	08S40805F05	Not Used
C9501	Capacitor	Not Used	Not Used	08S40805F05	Not Used
C9502	Capacitor	Not Used	Not Used	08S40805F05	Not Used
F1001	Fuse	65T55050F19	65T65292F03	65T42077U22	65T65292F03
F1301	Fuse	Not Used	65T66926F14	65T42077U08	65T42077U08
F1302	Fuse	Not Used	65T66926F14	65T42077U08	65T42077U08
F1303	Fuse	Not Used	65T66926F15	65T42077U08	65T42077U08
F1304	Fuse	Not Used	65T66926F15	65T42077U08	65T42077U08
F1305	Fuse	Not Used	65T66926F15	65T42077U15	65T42077U15
F1306	Fuse	Not Used	65T66926F18	65T42077U20	65T42077U20
J1001	Outlet, AC	09T67405F02	09T67405F02	Not Used	09T67405F02
J1002	Outlet, AC	09T67405F02	09T67405F02	Not Used	09T67405F02
J1003	Socket, Switch	Not Used	Not Used	09T51831F01	Not Used
L2101	Inductor	Not Used	Not Used	24T83130F02	Not Used
L2102	Inductor	Not Used	Not Used	24T83130F02	Not Used
L2103	Inductor	Not Used	Not Used	24T83130F02	Not Used
L2104	Inductor	Not Used	Not Used	24T83130F02	Not Used
P1001	Plug, AC Cord	28T67434F01	28T55335F02	28T43812P05	28T55335F02
P1002	Plug, Switch	Not Used	Not Used	09T51830F01	Not Used
Q3004	Transistor	48T81101F01	48S43525F05	48S43525F05	48S43525F05
Q4901	Tube	65T00091L03	65T00091L01	65T00091L01	65T00091L01
Q4902	Tube	65T00091L03	65T00091L01	65T00091L01	65T00091L01
R7341	Resistor	Not Used	06T00007L52	06T00007L52	06T00007L52
R7342	Resistor	Not Used	06T00007L52	06T00007L52	06T00007L52
RL1502	Relay	80T00048L01	80T83717F02	80T83717F02	80T83717F02
S1001	Switch	40T61963F02	40T61963F02	40T68579F01	40T61963F02
S1011	Switch	40T81345F01	40T83288F01	40T81345F01	40T92612F01
T1001	Transformer	25T81356F01	25T81356F03	25T81356F02	25T81356F03
7	Cover, Rear	15C81265F01	15C81265F05	15C81265F03	15C81265F07
20	Bush, Cap	43T53136F01	43T53136F01	Not Used	43T53136F01
26	Label, Fuse	54B62266F36	54B62266F53	54B62266F54	54B62266F53
31	Holder, Fuse	09T51960F01	09T51960F01	Not Used	09T51960F01
68	Assy., Front Panel	01V81600F58	01V83600F76	01V83600F76	01V83600F76
81	Label, Fuse	Not Used	54B62266F49	Not Used	Not Used

Symbol No.	Description	POWER SOURCE			
		JM ● 100V Japanese	UL ■ 120V North American	AM ▲ 220V European	UN ★ 120V Canadian
82	Label, Fuse	Not Used	54B62266F50	Not Used	Not Used
83	Label, Fuse	Not Used	54B62266F51	Not Used	Not Used
84	Holder, Fuse	Not Used	09T45548F01	09T45548F01	09T45548F01
85	Insulator	Not Used	Not Used	14A83125F01	Not Used
101-1	Owners, Manual	68P80130F59	68P81707F58	68P81707F59	68P81707F59
103	Carton, Packing	56S71001F74	56S71001F90	56S71001F90	56S71001F90

Semi-Conductor Lead Identifications

NJM78M12A : IC1119, 1120

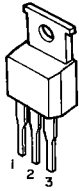

1 : INPUT
2 : COMMON
3 : OUTPUT

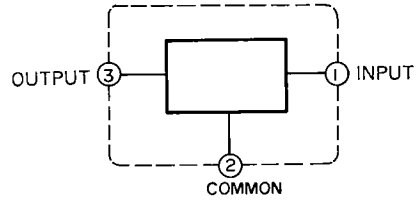

M5220P : IC2101
M5238P : IC4101

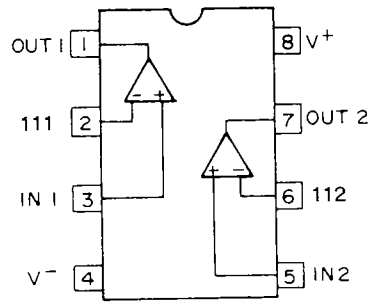
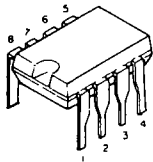

M51320P : IC3001

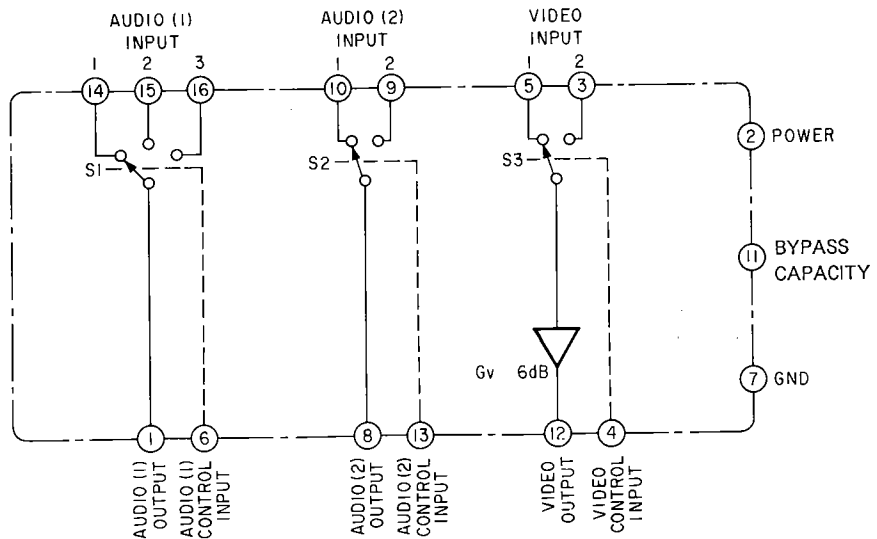
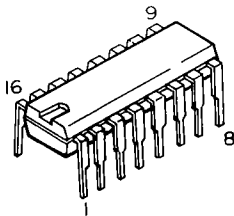

NJM4558D : IC4102

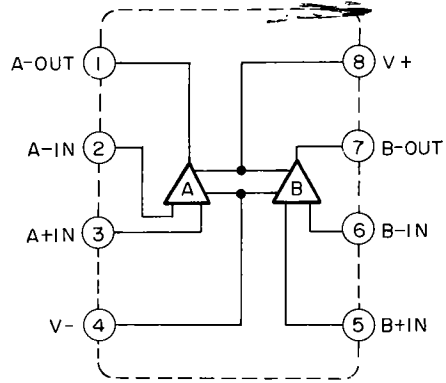
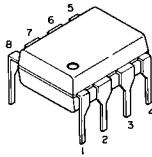

TA7317P : IC501

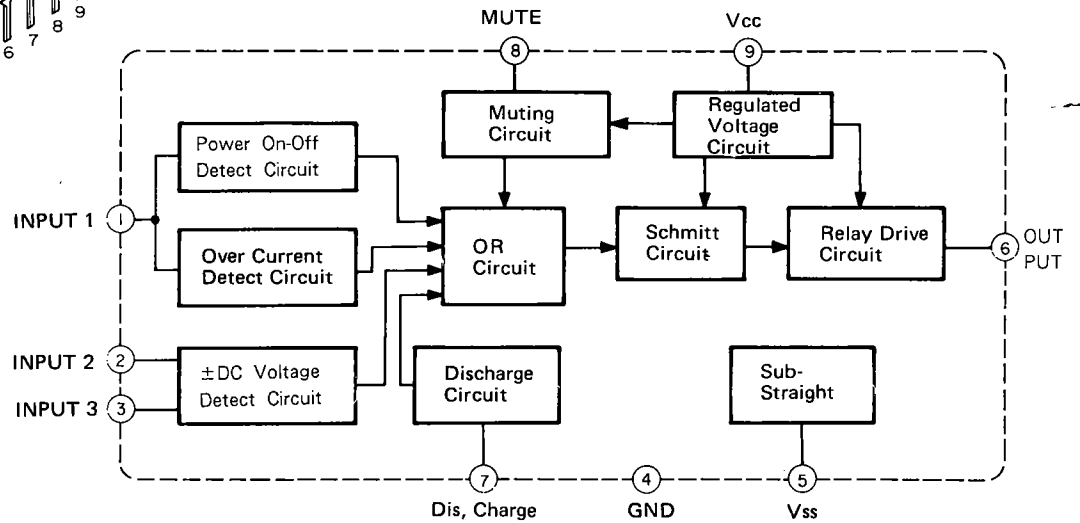
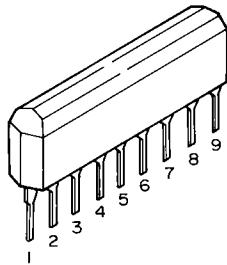

- 2SA1015 : Q1101, 1111, 1114, 1116, 5105
- 2SC1815 : Q1112, 1113, 1115, 1501
- 2SC2240 : Q5101, 7307, 7308, 7311, 7312
- 2SA970 : Q5104, 7309, 7310



2SD1266 : Q1012



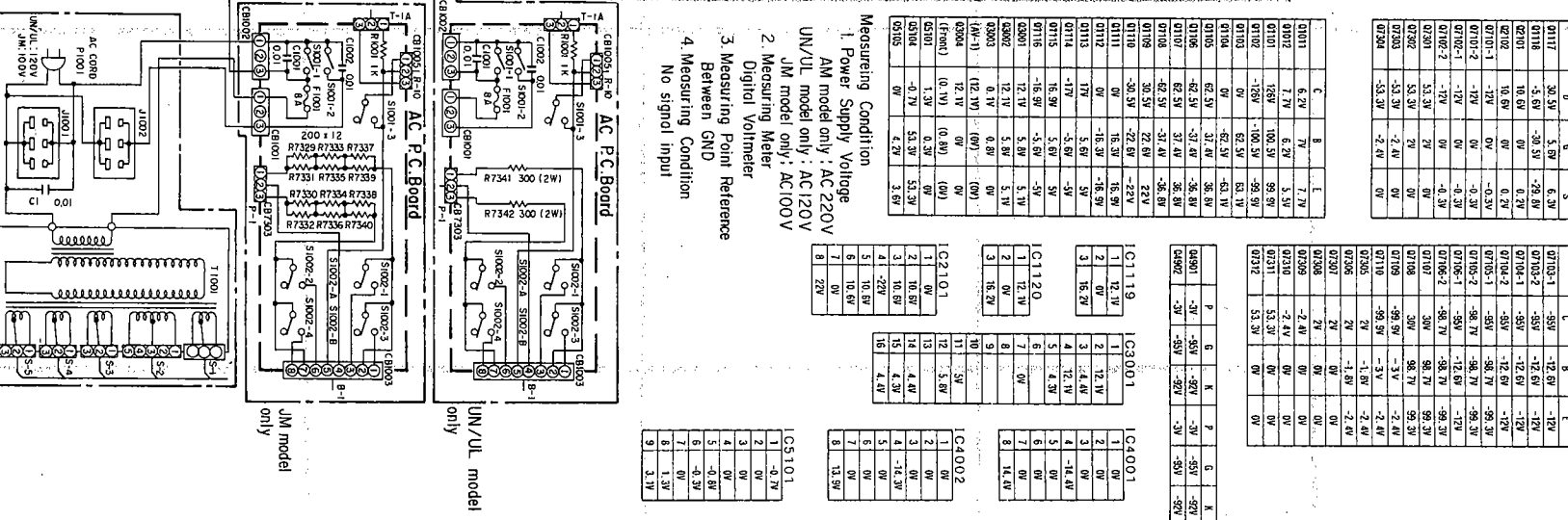
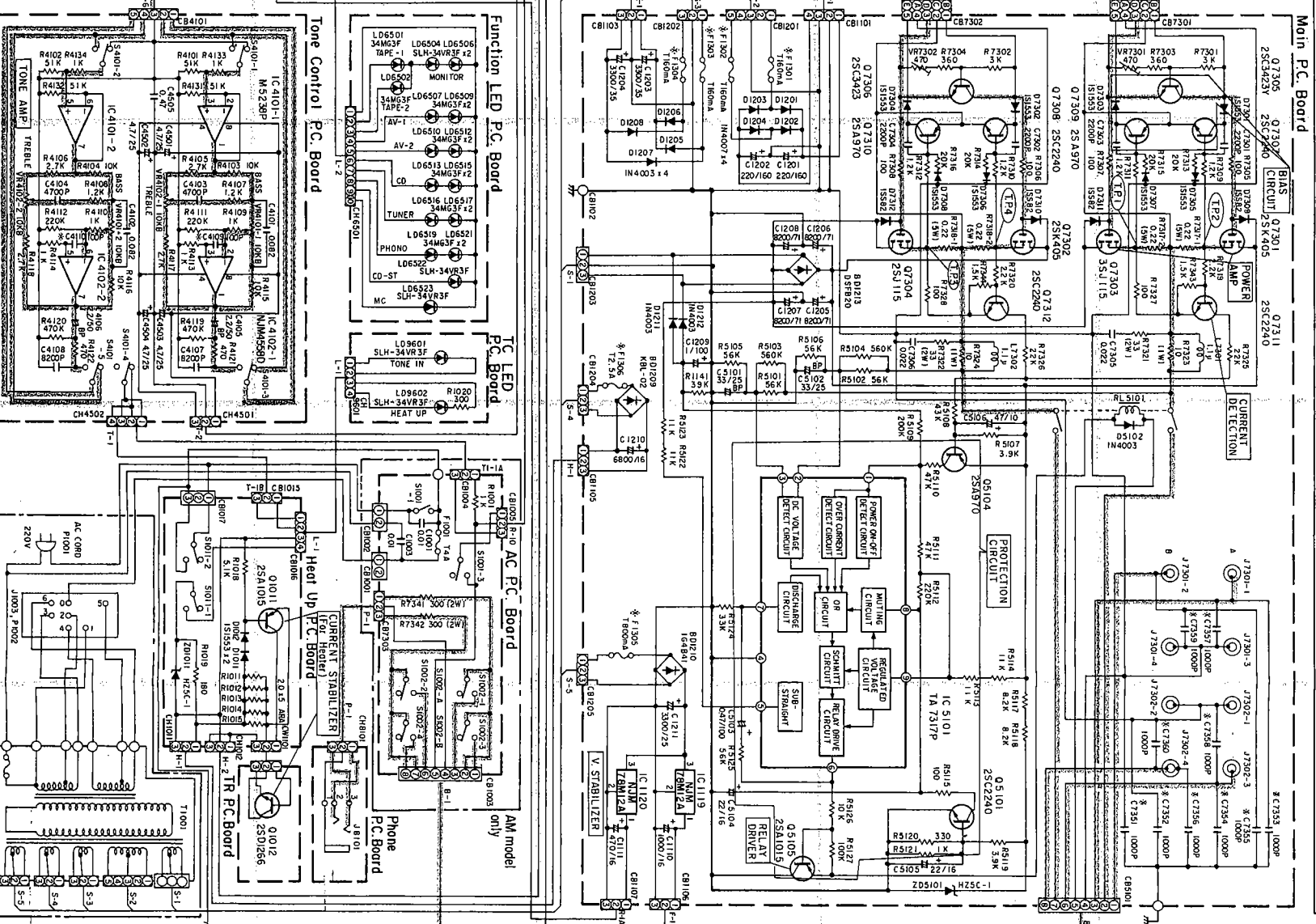
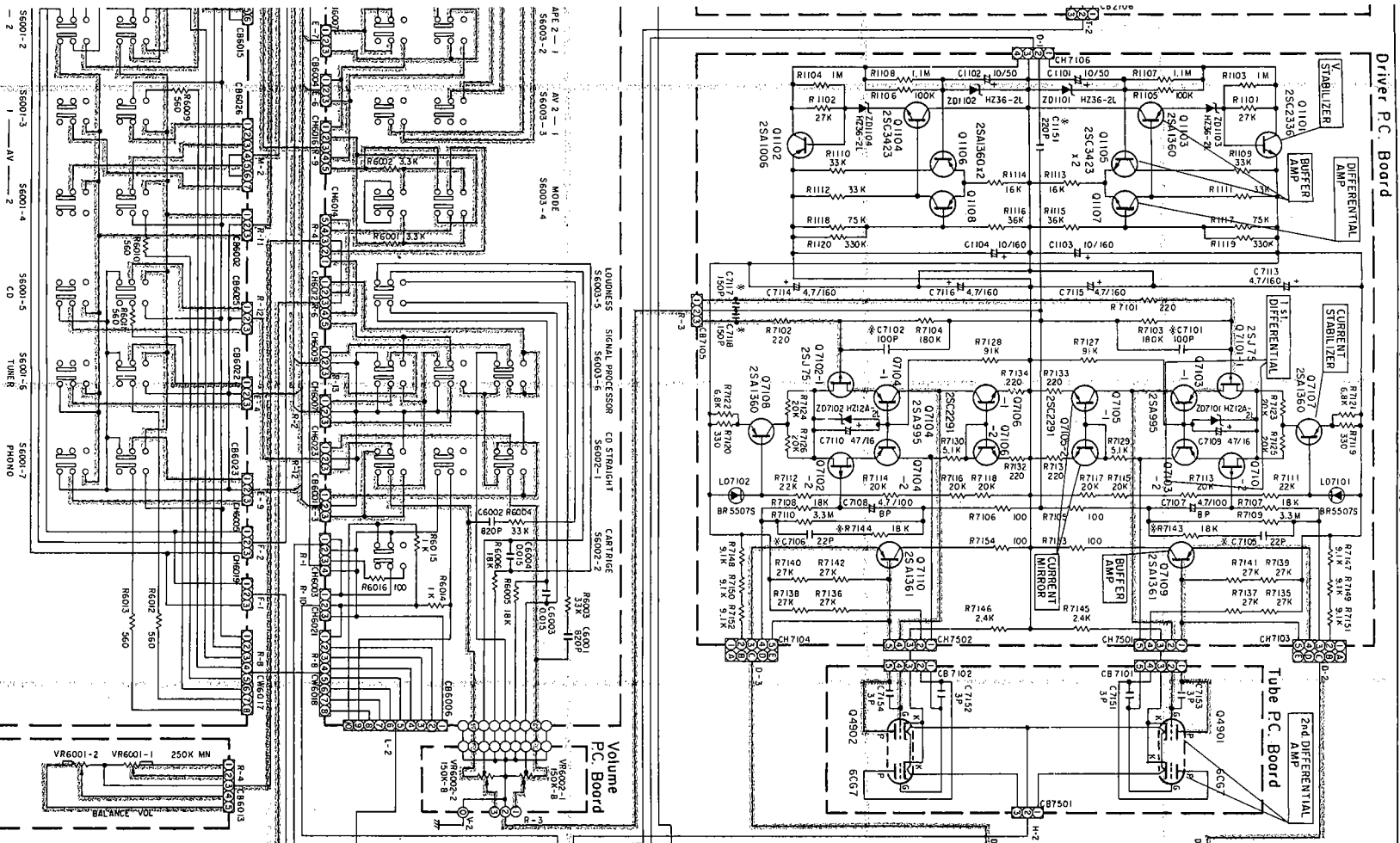

Measuring Condition

- Power Supply Voltage
- AM model only: AC 220V
- UN/UL model only: AC 120V
- JM model only: AC 100V
- Digital Voltmeter
- Measuring Point Reference Between GND
- Measuring Condition
- No signal input

Model	C	B	E
0111	6.2V	7V	7.7V
0112	1.7V	6.2V	5.5V
0110	189V	100.5V	93.9V
0102	-128V	-100.5V	-93.9V
0104	0V	-62.5V	63.1V
0106	-62.5V	31.4V	36.8V
0107	-62.5V	31.4V	36.8V
0108	-62.5V	31.4V	36.8V
0110	-30.5V	22.6V	-22V
0111	0V	-15.3V	-15.9V
0113	17V	-3.6V	3V
0115	-15.9V	3.6V	-3V
0116	-15.9V	3.6V	-3V
0117	12.1V	3.9V	3.1V
0118	12.1V	3.9V	3.1V
0119	12.1V	3.9V	3.1V
0120	12.1V	3.9V	3.1V
0121	12.1V	3.9V	3.1V
0122	12.1V	3.9V	3.1V
0123	12.1V	3.9V	3.1V
0124	12.1V	3.9V	3.1V
0125	12.1V	3.9V	3.1V
0126	12.1V	3.9V	3.1V
0127	12.1V	3.9V	3.1V
0128	12.1V	3.9V	3.1V
0129	12.1V	3.9V	3.1V
0130	12.1V	3.9V	3.1V
0131	12.1V	3.9V	3.1V
0132	12.1V	3.9V	3.1V
0133	12.1V	3.9V	3.1V
0134	12.1V	3.9V	3.1V
0135	12.1V	3.9V	3.1V
0136	12.1V	3.9V	3.1V
0137	12.1V	3.9V	3.1V
0138	12.1V	3.9V	3.1V
0139	12.1V	3.9V	3.1V
0140	12.1V	3.9V	3.1V
0141	12.1V	3.9V	3.1V
0142	12.1V	3.9V	3.1V
0143	12.1V	3.9V	3.1V
0144	12.1V	3.9V	3.1V
0145	12.1V	3.9V	3.1V
0146	12.1V	3.9V	3.1V
0147	12.1V	3.9V	3.1V
0148	12.1V	3.9V	3.1V
0149	12.1V	3.9V	3.1V
0150	12.1V	3.9V	3.1V
0151	12.1V	3.9V	3.1V
0152	12.1V	3.9V	3.1V
0153	12.1V	3.9V	3.1V
0154	12.1V	3.9V	3.1V
0155	12.1V	3.9V	3.1V
0156	12.1V	3.9V	3.1V
0157	12.1V	3.9V	3.1V
0158	12.1V	3.9V	3.1V
0159	12.1V	3.9V	3.1V
0160	12.1V	3.9V	3.1V
0161	12.1V	3.9V	3.1V
0162	12.1V	3.9V	3.1V
0163	12.1V	3.9V	3.1V
0164	12.1V	3.9V	3.1V
0165	12.1V	3.9V	3.1V
0166	12.1V	3.9V	3.1V
0167	12.1V	3.9V	3.1V
0168	12.1V	3.9V	3.1V
0169	12.1V	3.9V	3.1V
0170	12.1V	3.9V	3.1V
0171	12.1V	3.9V	3.1V
0172	12.1V	3.9V	3.1V
0173	12.1V	3.9V	3.1V
0174	12.1V	3.9V	3.1V
0175	12.1V	3.9V	3.1V
0176	12.1V	3.9V	3.1V
0177	12.1V	3.9V	3.1V
0178	12.1V	3.9V	3.1V
0179	12.1V	3.9V	3.1V
0180	12.1V	3.9V	3.1V
0181	12.1V	3.9V	3.1V
0182	12.1V	3.9V	3.1V
0183	12.1V	3.9V	3.1V
0184	12.1V	3.9V	3.1V
0185	12.1V	3.9V	3.1V
0186	12.1V	3.9V	3.1V
0187	12.1V	3.9V	3.1V
0188	12.1V	3.9V	3.1V
0189	12.1V	3.9V	3.1V
0190	12.1V	3.9V	3.1V
0191	12.1V	3.9V	3.1V
0192	12.1V	3.9V	3.1V
0193	12.1V	3.9V	3.1V
0194	12.1V	3.9V	3.1V
0195	12.1V	3.9V	3.1V
0196	12.1V	3.9V	3.1V
0197	12.1V	3.9V	3.1V
0198	12.1V	3.9V	3.1V
0199	12.1V	3.9V	3.1V
0200	12.1V	3.9V	3.1V

NOTES:
 1. All resistance values are in ohms. K = 1,000
 2. All capacitance values are in microfarads. P = 100,000

2SC2336 : Q1101
 2SA1006 : Q1102

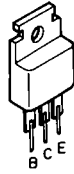

2SA1360 : Q1103, 1106, 1108, 1110, 7107, 7108
 2SC3423 : Q1104, 1105, 1107, 1109, 7305, 7306
 2SA1361 : Q7109, 7110

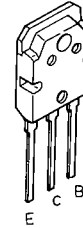

2SK30A : Q1117, 1118

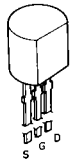

2SK332 : Q2101, 2102

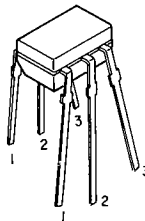

1. Drain
 2. Gate
 3. Source

2SJ75 : Q7101, 7102



1: DRAIN 1 4: DRAIN 2
 2: GATE 1 5: GATE 2
 3: SOURCE 1 6: SOURCE 2

2SA995 : Q7103, 7104
 2SC2291 : Q7105, 7106

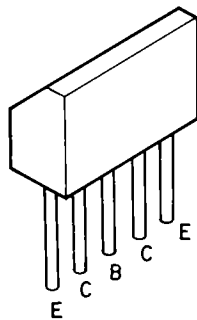

2SK405 : Q7301, 7302
 2SJ115 : Q7303, 7304

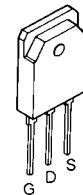



LUX CORPORATION, JAPAN

1-1-8 Nishi Gotanda, Shinagawa-ku, Tokyo, 141 JAPAN
Phone: 03-494-1101 Telex: 8927-61